

13th International Workshop for Young Scientists

BioPhys Spring 2014

BPS 2014



BOOK OF ABSTRACTS



Slovak University of Agriculture in Nitra
Slovak Republic



Institute of Agrophysics Polish Academy of Sciences
Lublin, Poland



Czech University of Life Sciences
Prague, Czech Republic



Szent Istvan University
Gödöllő, Hungary



Polish Academy of Science, Branch in Lublin
Poland

17-19.06.2014, Nitra, Slovak Republic

13th International Workshop
for Young Scientists
BioPhys Spring 2014
17-19.06.2014, Nitra, Slovak Republic

B P S

BOOK OF ABSTRACTS

Institute of Agrophysics
Polish Academy of Sciences
Lublin, Poland

Nitra, Slovak Republic, 17-19 June 2014

Edited by:
Józef Horabik, Justyna Szerement

Graphic design:
Justyna Szerement

ISBN 978-83-89969-23-1

Copyright© 2014 by the Institute of Agrophysics Polish Academy of Sciences,
Lublin, Poland

Edition: 100 copies

Printed by *ALF-GRAF* Lublin

CONTENTS

PREFACE BY PROFESSOR JIŘI BLAHOVEC

INTRODUCTION

SCIENTIFIC COMMITTEE

LECTURES

<i>Babić Mirko, Babić Ljiljana, Radojčin Milivoj, Stamenković Zoran, Pavkov Ivan:</i> Development of an original solar air heater for fruit drying.....	13
<i>Farkas Istvan:</i> Overview of solar energy use worldwide.....	15
<i>Hlaváčová Zuzana, Staroňová Lenka, Kardžilova Krassimira:</i> Electric properties of biological materials measuring techniques.....	18
<i>Horabik József:</i> Modeling of properties and processes in biomaterials by discrete element method.....	21
<i>Libra Martin:</i> Fundamental Problems of the Power Engineering in the 21 st Century.....	23
<i>Seres István, Víg Piroska:</i> Biophysical experiments.....	26
<i>Ślawiński Cezary:</i> Soil water hysteresis – the measurement and modelling.....	28
<i>Vozárová Vlasta, Valach Michal, Hřeš Lubomír, Petrović Ana, Csillag Ján:</i> Vegetable oils thermal properties and energy values.....	29

ORAL CONTRIBUTIONS OF YOUNG SCIENTISTS

<i>Albert Małgorzata, Wilczek Andrzej, Janik Grzegorz, Skierucha Wojciech, Błaś Marek, Sobik Mieczysław:</i> Application of TDR technique for determination of the effect of soil moisture on water infiltration from the atmosphere during effective non rainfall periods.....	32
<i>Ambrożewicz-Nita Anna, Józefaciuk Grzegorz, Szerement Justyna, Piasek Justyna, Kędziora Karolina:</i> The effect of addition of zeolite on changes in surface charge of selected soils.....	34
<i>Bartha Sándor, Ursu Viorel, Antal Noémi:</i> Solar and bio hydrogen production used for fuel cells energy conversion system.....	36
<i>Bilińska Nina, Frąc Magdalena:</i> Phosphorus and sulphur utilization profiles of two heat-resistant strains of <i>Neosartorya fischeri</i> using phenotype microarray (PM plates).....	38
<i>Bulak Piotr, Brzezińska Małgorzata:</i> Agents for chelate-assisted phytoextraction.....	40
<i>Chyba Jan, Kroulík Milan</i>	42
<i>Chylińska Monika, Szymańska-Chargot Monika, Zdunek Artur:</i> Classification of dietary fiber fractions from different sources based on FT IR and hierarchical cluster analysis.....	45
<i>Csáki Štefan, Štubňa Igor, Trnovcová Viera, Vozár Libor:</i> Geometrical factor and its uncertainty in a formula for electrical conductivity.....	47

<i>Cybulak Marta</i> : Determination of calcium, magnesium and potassium in fawn soil with biochar by atomic absorption spectroscopy.....	50
<i>Daniel Anna, Janik Grzegorz, Albert Małgorzata, Wolski Karol, Szyszkowski Paweł</i> : Application of TDR technique for estimating evapotranspiration.....	51
<i>Dlabal Lukáš, Polák Martin</i> : Influence of flow rate on the efficiency of sets with bladeless turbine.....	52
<i>Gackiewicz Bartłomiej, Lamorski Krzysztof, Sławiński Cezary</i> : Modeling of soil water transport - numerical implementation of the Richards equation.....	55
<i>Híreš Lubomír, Csillag Ján, Regrut Tomáš, Petrović Ana, Valach Michal</i> : The measurement of dynamic viscosity of bio lubricants with rheometer Anton Paar MCR 102.....	56
<i>Houška David, Křížová Marie</i> : Density analysis of selected components of sorted municipal waste.....	59
<i>Jaromin-Gleń Katarzyna</i> : Modeling of sewage purification in SBR reactors using a dedicated simulator.....	62
<i>Kabutey Abraham, Herak David, Sigalingging Riswanti</i> : Theoretical and experimental analysis of linear and non-linear compression of oilseed crops....	64
<i>Kędziora Karolina, Piasek Justyna, Szerement Justyna, Ambrożewicz-Nita Anna, Cieśla Jolanta, Józefaciuk Grzegorz</i> : Modification of zeolite surface charge for wastewater treatment.....	66
<i>Kocsány Ivett, Seres Istvan</i> : Influence of solar radiation on heat transfer process in solar collectors.....	68
<i>Koczańska Magdalena, Cieśla Jolanta, Bieganowski Andrzej</i> : The effect of preparation conditions on the sedimentation of clay suspension.....	70
<i>Kondracka Katarzyna, Nosalewicz Artur, Lipiec Jerzy</i> : Plant response to drought stress.....	71
<i>Kot Anna, Frąc Magdalena, Lipiec Jerzy</i> : Microbiological and biochemical properties of sludge from fruit wastewater treatment plant and its impact on soil environment.....	73
<i>Kotowicz Natalia, Frąc Magdalena, Lipiec Jerzy</i> : Application of biolog FF microplate™ for metabolic profiling of fungi from the genus fusarium.....	74
<i>Kozioł Arkadiusz, Cybulska Justyna, Kruk Beata, Sysa Dorota, Lekka Małgorzata, Zdunek Artur</i> : The study of Young's modulus of fruits during development using atomic force microscopy.....	76
<i>Kříž Milan</i> : Application of industry sensors for measuring of the soil roughness before tillage.....	77
<i>Kuna Jan, Bieganowski Andrzej</i> : Household wastes as a substrate for biogas production.....	80
<i>Kwietniewska Ewa, Tys Jerzy</i> : Anaerobic digestion of microalgal biomass.....	81

<i>Lalak Justyna, Tys Jerzy, Kasprzycka Agnieszka</i> : Ultrasonic pre-treatment of lignocellulosic biomass to improve anaerobic digestion.....	82
<i>Lev Jakub</i> : Capacitive throughput sensor and its sensitivity to the change of material properties.....	84
<i>Łukowska Małgorzata, Józefaciuk Grzegorz</i> : Determination of surface free energy of plant leaves.....	86
<i>Mierczyńska Joanna, Cybulska Justyna, Zdunek Artur</i> : High dietary fiber powder enriched with metal ions and ascorbic acid as a modifier of rheological properties of food.....	88
<i>Novák Ján</i> : Measurement of colza seeds conductivity.....	89
<i>Oleszek Marta, Kuna Jan, Tys Jerzy</i> : The possibilities of biogas production the Lubelskie province.....	91
<i>Panek Jacek, Frąc Magdalena</i> : Application of PCR method for detection of heat-resistant fungi belong to the <i>Talaromyces flavus</i> species.....	93
<i>Pastuszka Tomasz, Sławiński Cezary</i> : The influence of the organical sludges on hydrophysical soil properties.....	94
<i>Pastuszka-Woźniak Joanna, Baranowski Piotr</i> : Application of hyperspectral imaging to estimation of protein and water content of selected grains.....	95
<i>Paszkowski Bartosz</i> : Thermal characteristic of Acacia honey's dielectric permittivity.....	96
<i>Piasecka Agata, Krzemińska Izabela, Tys Jerzy, Wawrzykowski Jacek</i> : Microalgal cell disruption techniques.....	98
<i>Piasek Justyna</i> : Ion exchange and adsorption properties of modified zeolites.....	99
<i>Procházková Petra</i> : Building integrated wind turbines.....	100
<i>Radojčin Milivoj, Babić Mirko, Babić Ljiljana, Pavkov Ivan</i> : Effect of the osmotic pretreatment factors on physical properties of quince (<i>Cydonia Oblonga</i>) during combined drying.....	103
<i>Regrut Tomáš, Petrović Ana, Hřeš Lubomír, Csillag Ján, Valach Michal</i> : Measurement of density of biooils using densitometer Anton Paar M 5000.....	105
<i>Rusirawan Dani, Farkas István</i> : Single and double diode models of photovoltaic cells: evaluation of the methods and accuracy.....	108
<i>Siedliska Anna</i> : Hyperspectral Imaging as a tool for determining quality and phytochemicals concentration INsmall fruits.....	111
<i>Skic Kamil, Sokołowska Zofia</i> : The influence of the dairy sludge addition on the specific surface area of loess soil - the analysis of water vapour adsorption isotherms.....	112
<i>Solecki Grzegorz, Wilczek Andrzej, Szyplowska Agnieszka, Nakonieczna Anna, Paszowski Bartosz, Skierucha Wojciech</i> : Application of the fast Fourier transform method to the TDR signal analysis based on data from a vector network analyzer..	114

<i>Stelmach Wioleta</i> : The analysis of priming effect in soil contaminated by selected petroleum substances.....	115
<i>Szerement Justyna, Szatanik-Kloc Alicja</i> : The effect of cadmium ions to change the surface charge of celery (<i>Apium L.</i>) and parsnip (<i>Pastinaca sativa L.</i>) roots.....	117
<i>Szilágyi Attila, Seres István</i> : Solar cooling with absorption cooler in hungary.....	118
<i>Víg Piroska</i> : Examination of frozen water samples with fractal analysis.....	120
<i>Walkiewicz Anna, Brzezińska Małgorzata</i> : Effect of heavy metals on soil methanotrophic activity.....	123
<i>Wróbel Joanna, Nosalewicz Artur</i> : Physiological responses of cucumber plants with partial rootzone drying.....	125

PREFACE

I was asked to prepare “Preface” to Book of Abstracts of 13th BioPhys Spring held in Nitra. At this occasion, I would like to give some information concerning to this long-time and I think successful activity. At beginning, it exists problem of young scientists that visited different scientific conferences with posters without possibility to participate in the oral sessions. It was caused not only by quality of their contributions but also by their limited knowledge of language. I had an idea at that time, start to organize special conferences for young scientists, partly of a school character where the older scientists give information from the broader scientific disciplines and partly as a regulate conference for younger scientists, where they present their results exclusively orally.

In 2001 I discussed the idea with Professor Józef Horabik, and in 2002 the first workshop BioPhys Spring was organized. BioPhys (BPS) was determined as an abbreviation of physics and biology expressing the address of participants: physicists working in biology and similar disciplines. The word spring expressed two parameters: young peoples (up to 35 years) and time of the workshop, usually close to May 20. The first BioPhyses were organized directly by the young peoples: the first four years, in which the BPS was organized in Prague, the main student organizer was Dr. Viktor Mareš.

The first workshops were organized on the following rules: no fee, no service. Dr. Mareš collected applications from peoples and reserved with my help rooms in our dormitory, usually for one or two nights, in some cases the rooms were reserved for longer time and also for the accompany persons. The workshop was organised in some teaching room of our university, using the standard projectors.

The participants of the first workshop were 3 PhD students of University of Life Sciences in Prague, three further PhD students from Czech Republic and three PhD students from Institute of Agrophysics in Lublin (Poland). Information about the participants and their presentations are in following table:

Authors	Address	Title
<u>Gancarz, M.</u>	Institute of Agrophysics, PAS, Lublin	Composition method of microscope images for the potato tuber tissue structure investigation
<u>Holoubek, A.</u> , Veeeo, J., Sigler, K.	Institute of Microbiology, CAS	Plasma membrane vesicles - a model system for studying generation and maintenance of electrochemical proton gradient in yeast
<u>Kmentová, E.</u> , Janeárová, R., Kummerová, M.	Masaryk University, Brno	Influence of fluoranthene on primary processes of photosynthesis of leaves and isolated chloroplasts of Pea plants
<u>Mareš, V.</u>	CULS Prague	The measurement of microhardness of wood of Norway spruce (<i>Picea abies</i> L.) stored for a long time in the temperature 50°C
<u>Nedomová, Š.</u> , Simeonovová, J., Máchal, L., Buchar, J.	Mendel's Agricultural and Forest University Brno	Mechanical characteristics of eggshell of different strains and lines of laying hens measured by destruction method
<u>Rusinek, R.</u>	Institute of Agrophysics, PAS, Lublin	Experimental method for determination of the pressure distribution in granular solids
Stasiak, M.	Institute of Agrophysics, PAS, Lublin	Determination of elastic parameters of grain with oedometric and acoustic methods
<u>Šařec, O.</u> , <u>Šařec, P.</u> , Prošek, V.	CULS Prague	Soil electrical conductivity - application in agriculture
Vlčková, M., Blahovec, J.	CULS Prague	Determination of the pear sensitivity to bruising by compression test

Prague workshops were connected usually with optional walk trips to different places in Czech Republic: Říp mountain, Blaník mountain, old castle Levý Hradec, etc. In middle of 2000-th, number of foreign participants at BPS increased and participants from Lublin started to form the biggest group among them. This is why the organization started to move between Prague and Lublin and later between Prague, Lublin, Nitra and Gödöllő. This is another step in the history of BPS; the workshop started to be big, better organized, but also more expensive. Present BPS needs to find sponsors or the alternative source of many for paying expenses that are only little cheaper than the other standard conferences.



Viktor Mareš (on the right) with me during spring trip to Milešovka mountain (2004).

Prague June 2nd 2014

Jiří Blahovec
Organiser of several BPS

INTRODUCTION

Dear friends and colleagues,

It is our privilege and great pleasure to invite you on behalf of organising institutions - Department of Physics of Slovak University of Agriculture in Nitra together with The Bohdan Dobrzański Institute of Agrophysics of the Polish Academy of Sciences and Lublin Branch of Polish Academy of Sciences - to participate in the 13th International Workshop for Young Scientists "BioPhys Spring 2014" to be held in Nitra on 17-19th June 2014.

The workshop is oriented on deeper insight into the physical processes occurring in biological, agricultural and food systems. The workshop combines two basic tasks of international meeting: exchange of professional experience and integration of young people from different countries.

We cordially invite young scientists to participate in the BPS 2014 Workshop and to present results of your research in application of physical methods to agriculture, biology and/or life sciences. **The workshop is organised as an opened English spoken event without any fee.** One or two-pages abstracts of contributions will be published in the Book of Abstracts of the BPS 2014 Workshop. Papers can be submitted for publication to International Agrophysics, Acta Agrophysica, Research in Agricultural Engineering, Scientia Agriculturae Bohemica or Acta Technologica Agriculturae.

It is my pleasure to invite you to spend a few days of June 2014 in friendly atmosphere between young people in Nitra.

Vlasta Vozárová
Chairman of the Scientific Committee

SCIENTIFIC COMMITTEE

Józef Horabik	Institute of Agrophysics Polish Academy of Sciences, Lublin, Poland
Jiří Blahovec	Czech University of Life Sciences, Prague, Czech Republic
István Farkas	Szent István University, Gödöllő, Hungary
Jan Gliński	Lublin Branch of Polish Academy of Sciences, Lublin, Poland
Krystyna Konstankiewicz	Institute of Agrophysics Polish Academy of Sciences, Lublin, Poland
Martin Libra	Czech University of Life Sciences, Prague, Czech Republic
István Seres	Szent István University, Gödöllő, Hungary
Zuzana Hlaváčová	Slovak University of Agriculture Nitra, Slovak Republic
Vlasta Vozárová	Slovak University of Agriculture, Nitra, Slovak Republic

ORGANIZING COMMITTEE

Vlasta Vozárová	Slovak University of Agriculture, Nitra, Slovak Republic
Zuzana Hlaváčová	Slovak University of Agriculture, Nitra, Slovak Republic
Ana Petrović	Slovak University of Agriculture, Nitra, Slovak Republic
Justyna Szerement	Institute of Agrophysics, Polish Academy of Sciences, Lublin, Poland

LECTURES

DEVELOPMENT OF AN ORIGINAL SOLAR AIR HEATER FOR FRUIT DRYING

*Mirko Babić, Ljiljana Babić, Milivoj Radojčin, Zoran Stamenković,
Ivan Pavkov*

Department of Agricultural Engineering
University of Novi Sad, Faculty of Agriculture,
Trg D. Obradovića 8, 21000 Novi Sad, Serbia
mbab@polj.uns.ac.rs

High investment costs hinder or restrain the use of renewable energy sources, especially the use of solar energy. Notwithstanding the low exploitation price, solar energy is still fairly underutilised. The most dominant mean of solar energy use is generating electrical energy by solar conversion in photovoltaic cells. In the southern European countries, there is a significant use of solar energy for heating non-potable water and households during the winter. Nevertheless, technological needs for other types of thermal energy occur in the summer as well. Drying agricultural products is an important technological operation, especially fruits, vegetables and similar biomaterials harvested during the summer or early in the autumn. The moisture content of such products is very high and in various continental fruit species ranges from 80% to 90%. The rationalisation of the drying process can be obtained by the use of solar energy. Fruit drying is mostly done conventionally by means of the heated air. In the Mediterranean countries, a method of drying by direct exposure to the sun is commonplace (Fig. 1-A). Figs, grapes, apricots and dates are dried in this manner. Although such traditional drying has numerous hygienic disadvantages, it is not applicable in the continental parts of Europe. In order to reduce investment costs, the solar air heating process ought to be straightforward and direct. Air heating in a box-type solar collector is a widespread method (Fig. 1-C).

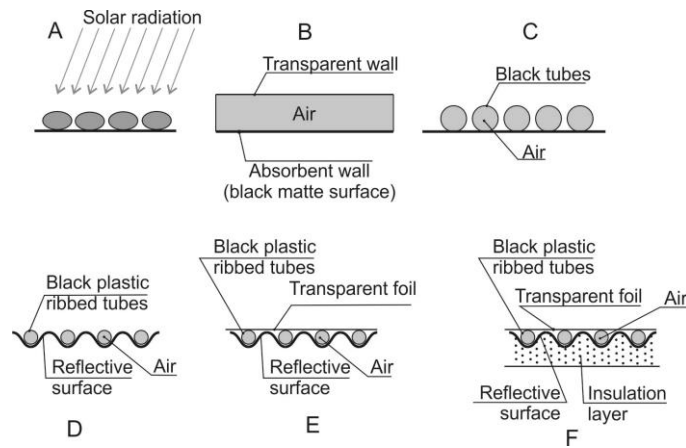

Fig. 1. Different types of solar energy use for fruit drying

A – Direct drying, B – Box heater, C – Ordinary row tubes, D - Tubes in a sinusoidal roof, E - Tubes in a sinusoidal roof with transparent foil and F - Tubes in a sinusoidal roof with transparent foil and insulation bottom.

Fruit dryers are usually placed in a roofed space. The development of an original self-designed air heater started when a fruit dryer was placed under a flat concrete roof. Black flexible ribbed tubes were placed in a row (Fig. 1–C). Air entered at one end and streamed to a collection tube at the other where it was blown by fans. Such solar heater was very inexpensive and also very inefficient due to massive heat losses. Nevertheless, it could be used in specific cases. The commonest type of a roof consists of sloping wavy sheets. The idea was to place black flexible ribbed tubes in the existing channels of a wavy roof, which would require minimal investments. Moreover, the idea incorporated a more efficient semi-concentrating absorption system (Fig. 1–D). A sinusoidal roof is the most favourable of all wavy roofs. The model was further improved by placing a three-layer foil in order to reduce the heat emission of the black tubes – the greenhouse effect (Fig. 1–E). Admittedly, the insulation at the bottom reduces heat losses and increases the utilisation of solar radiation (Fig. 1–F).

The most efficient system enables the utilisation of solar radiation up to 50%. Specific investment costs are the decisive factor in choosing the system. They can be expressed as investment costs per 1 kW of nominal thermal power, which is the output of a solar-based air heating system.

ACKNOWLEDGEMENTS

This paper is a result of the research within the project TR31058, 2011-2014. financed by the Ministry of Education, Science and Technological Development of the Republic of Serbia.

REFERENCES

1. BABIĆ M., BABIĆ L., MATIĆ-KEKIĆ S., KARADŽIĆ B., PAVKOV I. 2005. Energy sustainable model of dried fruit production by combined technology. Journal on Processing and Energy in Agriculture (former PTEP), 9(5), p.109-111.
2. GUPTA M.K., KAUSHIK S.C. 2008. Exergetic performance evaluation and parametric studies of solar air heater, Energy, 33, p. 1691-1702.
3. KUDRA T., MUJUMDAR A.S. 2002: Advanced Drying Technologies; Marcel Dekker, Inc.: New York.
4. YADAVA S., KAUSHAL M., VARUNC S.2014. Exergetic performance evaluation of solar air heater having arc shape oriented protrusions as roughness element, Solar Energy 105, p.181–189.

OVERVIEW OF SOLAR ENERGY USE WORLDWIDE

Istvan Farkas

Department of Physics and Process Control,
Szent Istvan University
H-2100, Gödöllő Pater K. u.1., Hungary
Farkas.Istvan@gek.szie.hu

The paper is going to deal with the overview of the worldwide position of the solar energy applications. Beside the technological issues the environmental questions will also be discussed. The worldwide situation is analysed based on the recent development shown intensively at the Solar World Congress organized by the International Solar Energy Society at Cancun, Mexico in 2013. Additionally, the most recently published books in this topic served also a basic source to the overview statements.

Within the congress beside the technical-scientific topics several forums were organized to talk on local, national and international problems of energy politics which are responsible for the wider dissemination such technologies.

The main thematic questions are as follows:

1. Social aspects of the use of solar energy
2. Radiation, solar potential
3. Passive architecture
4. Collector technologies, systems and applications
5. Solar heating and cooling
6. PV technologies, systems and applications
7. Photovoltaic plants
8. Energy storage
9. Strategy and market questions
10. Education

Concerning to the future vision several recently published books are available which are listed in the reference list.

Focusing the solar heat worldwide the following main comments can be drawn:

In the share of the total installed capacity in operation (including the glazed and unglazed water and air collectors) China took over the leading position with about 65%, following by Europe with about 17% and USA/Canada with about 7%.

Until to the end of 2012 the main indicators are as follows:

Total capacity built in: 268,1 GW
 Total built in collector are: 383 m²
 Yearly energy yield: 225 TWh
 Oil equivalent saving: 24 m tonne
 CO₂ emission saving: 73,7 m tonne

Just making a comparison of the different total renewable energy capacities in operation and their produced energy in 2012 is shown in Fig. 1, where it can be easily justified the importance of the solar heat (Mauthner and Weiss, 2013).

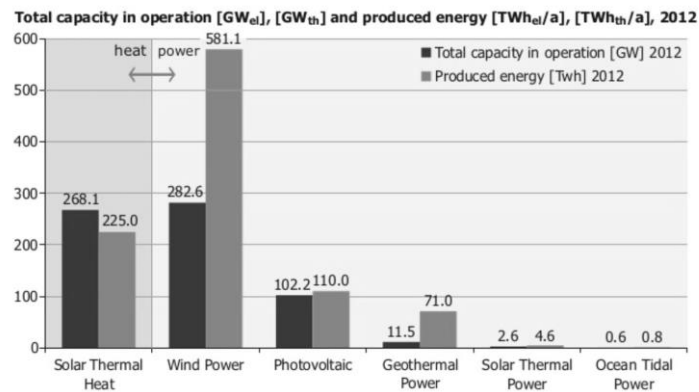

Fig. 1. The total renewable capacity and energy produced in 2012.

The main issues of the use of solar thermal energy in Europe can be summarized along with the statements as:

- mainly solar domestic hot water systems are in use,
- growing share of combined systems,
- growing number of collective (large) systems,
- plastic absorber for swimming pool collectors,
- several solar district heating systems,
- some pilot plants for process heat,
- about 200 pilot plants for solar thermal assisted cooling system.

ACKNOWLEDGEMENTS

This research was supported by the OTKA K84150 project.

REFERENCES

1. MAUTHNER F., WEISS W., 2013 Edition, Heat worldwide, Markets and contribution to the energy supply – 2011, SHC - Solar Heating and Cooling Programme, International Energy Agency.
2. Renewables 2013 - Global Status Report, REN 21, Renewable Energy Policy Network for the 21st Century.
3. RE-thinking 2050., 2013. A 100% Renewable Energy Vision for the European Union, EREC – European Renewable Energy Council.
4. SDH - Solar district heating, 2012, Market for solar district heating, CIT Energy Management AB.
5. Strategic research priorities for solar thermal technology, 2013, RHC – Renewable Heating and Cooling European Technology Platform.
6. WEISS W., 2013, Current status of solar thermal application worldwide, AEE, Institute for Sustainable Technologies, Gleisdorf, Austria.

ELECTRIC PROPERTIES OF BIOLOGICAL MATERIALS MEASURING TECHNIQUES

Zuzana Hlaváčová¹, Lenka Staroňová², Krassimira Kardžilova³

¹Department of Physics, ²Department of Production Engineering,
Slovak University of Agriculture in Nitra
Tr. A. Hlinku 2, 949 76 Nitra, Slovakia
zuzana.hlavacova@uniag.sk, lenka.staronova@uniag.sk
³Department of Physics, Technical University in Varna
Studentska Str .1, 9010 Varna, Bulgaria
kardzilova@yahoo.com

Electrical properties of different complex materials can be used to sense non-electrical characteristics of those materials when the conductivity, permittivity, and other electrical properties, of those materials are correlated with the non-electrical material characteristics. Electric properties are the properties which characterize transport of charge carriers in the material or propagation of electromagnetic waves in material. Into electrical properties can be included electric conductance, conductivity, electric resistance, resistivity, impedance, admittance, permittivity, relative permittivity, complex permittivity with the components – real part which is equal to permittivity and imaginary part characterizing dielectric losses in material, further we can mention dielectric loss angle, loss tangent, Maxwell relaxation constant (Hlaváčová, 2011).

The measurement methods are classified from various points of view. Electric measurements by direct current are strongly influenced by the polarization effects at material high moisture content. For the electrodes polarization removal we used most frequently the alternate current. The frequencies normally used for conductivity measurement are in the range 1 – 500 kHz. Various techniques have been developed to study the permittivity of agricultural materials. The bridges method are used for measurement at the frequency range up to 10^2 Hz, substitution method is used in frequency range from 10^2 Hz to 10^5 Hz. Resonance methods are applicable most frequently in the range 10^5 Hz to 10^8 Hz. Furthermore, pulse method, TDR - Time Domain Reflectometry, GPR - ground penetrating radar, measurements using open resonators etc. are utilized in higher frequencies.

The measurement methods relevant for any desired application depend on the nature of the dielectric material to be measured, both physically and electrically, the frequency of interest, and the degree of accuracy required. Despite the fact that different kinds of instruments can be used, measuring instruments that

provide reliable determinations of the required electrical properties involving the unknown material in the frequency range of interest can be considered (Nelson, 1998).

The challenge in making accurate permittivity or dielectric property measurements is in designing of the material sample holder for those measurements (RF and MW frequency ranges) and adequately modelling the circuit for reliable calculation of the permittivity from the electrical measurements. Results of grain and seed samples tested using a Q-meter based on resonant circuit have been documented in the 1 MHz to 50 MHz range (Nelson 1991). Other techniques were designed and developed for higher frequency ranges with coaxial sample holders modelled as transmission-line sections with lumped parameters and measured with an RX- meter for the 50 MHz to 250 MHz range and for the 200 MHz to 500 MHz range, measured with an admittance meter. Lawrence et al. (1998) have designed and modelled a coaxial sample holder to accommodate flowing grain and characterized by full two-port parameter measurements, with the use of several organic solvents such as alcohols of known permittivities, and signal flow analysis, to offer dielectric properties of grain over a range of 25 MHz to 350 MHz. At MW frequencies, generally about 1 GHz and higher, transmission-line, resonant cavity, and free-space techniques have been commonly used. Dielectric property measurement techniques can be categorized as reflection or transmission types using resonant or no resonant systems, with open or closed structures for sensing of the properties of material samples (Kraszewski, 1980). Waveguide and coaxial line transmission measurements represent closed structures while the free-space transmission measurements and open-ended coaxial-line systems represent open-structure techniques, respectively. Resonant structures can include either closed resonant cavities or open resonant structures operated as two-port devices for transmission measurements or as one-port devices for reflection measurements (Nelson 1998).

Electric properties measurement method can be classified from various points of view. We can name:

- measured material (liquid, porous, granular, one grain measurement, pack of seeds, ...)
- sensor (capacitor, open resonator, coaxial probe, ...)
- frequency (direct current, alternate current with various values of frequency, ...)
- accuracy

Dielectric spectroscopy, which describes the dielectric properties of a sample as a function of frequency, may be successfully used for examinations of properties of various materials. The dielectric properties, uniquely describing each

complex material (consisting of various substances mixed in different proportions), may provide information about its quality (Skierucha, Wilczek and Szyplowska, 2012). Microwave measurements and the dielectric properties of materials are finding increasing application as new electro-technology is adapted for use in the agriculture and food processing industries (Venkatesh, Raghavan, 2005).

Various techniques have been developed to study the dielectric properties of biological materials. We can classified them

- bridges method - up to 100 Hz
- substitution method – 100 Hz - 100 kHz
- resonance methods (Q – Meter) - 100 kHz - 100 MHz
- pulse method – 10 MHz – 10 GHz
- TDR - Time Domain Reflectometry (MW)
- GPR - ground penetrating radar (MW)
- airborne/satellite active radar (MW)
- passive microwave methods – 1 GHz

According the used sensor we can classified these method as capacitance, wave guide measurements, cavity measurements, open resonator, coaxial probe, non contact scattering measurements, transmission line method, free space transmission method.

ACKNOWLEDGEMENTS

This work was co-funded by European Community under project no 26220220180: Building Research Centre „AgroBioTech“.

REFERENCES

1. HLAVÁČOVÁ Z., 2011. Electrical Properties of Agricultural Products. p. 237-241. In: Encyclopedia of Agrophysics. Editors Glinski, J., Horabik, J., Lipiec, J. Dordrecht: Springer Science + Business Media, 2011, 1032 p.
2. LAWRENCE K.C., NELSON S. O., BARLEY Jr., P. G.: Coaxial dielectric sensor for cereal grains. In Proceedings IEEE IMTC 1:541-546, 1998.
3. KRASZEWSKI A.W., 1980. Microwave aquametry - A review. Journal of Microwave Power. 15(4), 1980, 209-220.
4. NELSON S.O., 1991. Dielectric properties of agricultural products - Measurements and applications. IEEE Transactions of Electrical Insulation, 1991, 26(5), p. 845-869.
5. NELSON S.O., 1998. Dielectric properties measuring techniques and applications. ASAE Paper No. 983067. St. Joseph, MI: ASAE. 1998.
6. SKIERUCHA W., WILCZEK A., SZYPLOWSKA A., Dielectric spectroscopy in agrophysics. International Agrophysics. 26(2), 2012, p.187-197.
7. VENKATESH M.S., RAGHAVAN G.S.V., An overview of dielectric properties measuring techniques. Canadian Biosystems Engineering, 2005, 47, p. 7.15-7.30.

MODELING OF PROPERTIES AND PROCESSES IN BIOMATERIALS BY DISCRETE ELEMENT METHOD

Józef Horabik

Department of Physical Properties of Plant Materials
Institute of Agrophysics Polish Academy of Sciences
Doświadczalna 4, 20-290 Lublin, Poland
e-mail: j.horabik@ipan.lublin.pl

Computer simulations belong to the most important methods of theoretical investigation of assemblies of large number of particles. Such simulations of processes of technological relevance became possible due to the enormous advances in computer technology. One of these methods is the Discrete Element Method (DEM) originally pioneered by Cundall and Strack (1979) to study rock mechanics. Today the method is applied to many areas of research and technology comprising quasi-static, impact or explosive loading, employing elementary particles of different shapes and density, connected by different rheological cohesive, massless elements. Newton's equations govern the translational and rotational motion of the elements. Torques and forces can arise either from particle-particle interactions, volumetric forces, from the cohesive elements, by interaction with rigid or elastic boundaries (Wittel et al., 2008).

Applications of the DEM for modeling of agricultural processes is still rather scarce. Biomaterials constitute a wide group distinguished by large deformability, low strength, irregular shape and strong dependence of mechanical properties on moisture content which creates complex task for the DEM modeling. Very important issue in the investigations of these systems is related to contact mechanics during collisions with other objects (grains, fruits or machines) during harvesting and post-harvesting treatment and its effect on material failure. Wojtkowski et al. (2010) indicated that an elasto-plastic contact model was efficient for simulation of the impact behavior of dry rapeseed, whereas a visco-elastic model gave closer estimates for wet seeds. Van Zeebroeck et al. (2003) found that for impact of soft fruits and tubes the Kuwabara-Kono visco-elastic contact model provides sufficient accuracy.

In last decade several new interactions between particles were introduced to the DEM models which results in considerable broadening of applications. One of them is an assumption that two adjacent particle centers are bonded by a fictitious elastic beam element. The Bonded-Particle Model (BPM) is very convenient tool of mimic complex systems and thus exhibits a rich set of emergent behaviors that correspond very well with those of real systems. The BPM provides both a

scientific tool to investigate the micromechanisms that combine to produce complex macroscopic behaviors and an engineering tool to predict these macroscopic behaviors (Potyondy and Cundall, 2004). For example an flexible fiber can be composed of a set of connected particles. The elongation, shearing, bending, and torsion can be applied to the adjacent particles resulting in appropriate reaction of the beam composed of connected particles (Nguyen et al., 2013). Lenaerts et al., (2014) have applied the BPM to model grain–straw separation with spherical grain particles and segmented elastic straw fibers made up of cylindrical and spherical DEM elements.

Application of breakable bonds (bonds with threshold of strain and bending) between segments (Wittel et al., 2008) together with particle cohesion considerably extends the range of real processes in biomaterials which can be modeled with the DEM. It provides a scientific tool of study of biomaterials agglomeration, briquetting and fragmentation during impacts. The aim of this contribution is to review recent studies in the DEM modeling of agricultural processes and properties of biomaterials.

REFERENCES

1. CUNDALL P.A., STRACK O.D., A discrete element model for granular assemblies, *Géotechnique*, 29(1), 47-65, 1979.
2. LENAERTS B., AERTSEN T., TIJSKENS E., KETELAERE B., RAMON H., DE BAERDEMAEKER J., SAEYS W., Simulation of grain–straw separation by Discrete Element Modeling with bendable straw particles. *Computers and Electronics in Agriculture*, 101, 24–33, 2014.
3. NGUYEN D.H., KANG N., PARK J., Validation of partially flexible rod model based on discrete element method using beam deflection and vibration. *Powder Technology*, 237, 147–152, 2013.
4. POTYONDY D.O., CUNDALL P.A., Bonded-particle model for rock. *Int J Rock Mechanics & Mining Sciences*, 41, 1329–1364, 2004.
5. WITTEL F.K., CARMONA H.A., KUN F., HERRMANN H.J., Mechanisms in impact fragmentation. *Int J Fract*, 154, 105–117, 2008.
6. WOJTKOWSKI M., PECEN J., HORABIK J., MOLENDNA M., Impact of rapeseed against flat surface: Physical testing and DEM simulation with two contact models. *Powder Technol*, 198, 61-68, 2010.
7. VAN ZEEBROECK M., TIJSKENS E., VAN LIEDEKERKE P., DELI V., DE BAERDEMAEKER J., RAMON H., Determination of the dynamic behaviour of biological materials during impact using a pendulum device, *J Sound and Vibration*, 266, 465–480, 2003.

FUNDAMENTAL PROBLEMS OF THE POWER ENGINEERING IN THE 21st CENTURY

Martin Libra

Czech University of Life Sciences Prague,
Kamycka 129, 16521 Prague 6, Czech Republic

Sustainable development is a frequently discussed topic nowadays. Future technological development cannot continue to be based on growth of production and consumption of fossil fuel based sources (oil, coal, natural gas) because deposits are gradually being exhausted. They also represent a considerable burden for the environment. At present the consumption of energy from fossil fuels is much faster than its accumulation. Hopefully, there is general recognition that adoption of renewable energy sources is the only viable alternative for growth of our civilisation. International political and scientific conferences have been organised to deal with this problem, including the key Kyoto conference in 1997. The conference in Bali 2007 was not that successful. Total energy production on Earth is growing exponentially; in the year 2000 it already exceeded $E = 10^{14}$ kWh/year. If this trend continues it would reach $E = 10^{17}$ kWh/year within less than a century. This would be a catastrophic scenario which global ecosystems would probably not survive. Alongside power production itself many well-known and much discussed side effects need to be taken into consideration, such as emissions of dangerous or even poisonous gases, production of fly-ash, radioactive waste, emissions of greenhouse gases, acid rain, global warming, and melting of glaciers. It should be stressed that during the last Ice Age the average temperature was only 4°C lower than today and that, based on recent estimates, average temperature could grow by 4°C within next 50 years. This increase would have a catastrophic impact on global ecosystems. The most pessimistic scenarios estimate average temperature growth of as much as 9°C within next century. The concentration of atmospheric CO₂ grows by 0.4% annually and the concentration of methane grows even faster. The greenhouse effect is probably the cause of current high-risk climate change. Greenhouse gases absorb infrared radiation from the Earth's surface, partly reflecting it. This effect disturbs the balance between energy absorbed and radiated by the Earth. So far it has not been proved beyond doubt that these climate changes are caused by human activity. Rapid climate change and fluctuation of sea level by as much as 100 m in periods of the order of a thousand years have occurred historically.

A coal power plant with output $P = 1000 \text{ MW}_e$ pollutes the atmosphere with about 10^{10} kg of CO₂ annually, to say nothing of other gases such as SO₂ and fly-

ash (often slightly radioactive). These emissions occur even from plants with high-quality desulphurization units and fly-ash separators, causing acid rain and reduction of soil and water pH.

Some hope comes from prognoses that we cannot extrapolate recent trends, and that energy production will saturate, e.g., by implementation of power saving technologies, and that the curve of energy production in time will approach the asymptotic level of $E = 10^{16}$ kWh/year, which will never be exceeded. Such a trend might perhaps be acceptable from the point of view of sustainable development. But prognoses vary to a great degree and only time will tell which is the correct one.

Recent oil consumption has already reached its maximum and should decrease considerably. In the next 50 years, oil consumption should drop to about one half of its present level. Consumption of coal should start decreasing around 2040. On the other hand, utilisation of solar and nuclear energy grows rapidly.

Even in prehistoric times, humans realised the criticality of energy sources for all life and worshipped sources of light and heat as gods. Solar radiation is the most important renewable and clean energy source, the most promising source from a long-term perspective. This is why so much attention is given to the problems of its utilisation. States with developed industry, but with minimum own resources of energy, invest large sums into research in this field. Probably the most striking situation in this respect is in Japan. Our planet absorbs permanently about $P = 1.8 \times 10^{17}$ W of solar radiation, with slight fluctuations due to solar activity and seasonal effects (as the Earth's orbit is elliptic). This is by three orders of magnitude higher than the whole energy production and consumption of mankind. However, it must be taken into consideration that only a small part of the incident energy can be utilised. So far solar energy is not able to compete with high-capacity power plants burning fossil fuels, with nuclear power stations, or with hydroelectric power plants. But it has been already successfully applied as a supplementary local power source, and, as mentioned above, its importance is growing rapidly. Solar power stations with ten MW_p of output have already been built and even larger ones are being designed.

Solar energy is particularly important in remote areas of the Earth that are not connected to the electricity grid and where building such a network would be economically unviable. Hydroelectric power is not always at hand in these areas and combustion engine generators are dependent on permanent supplies of gasoline or crude oil. Low direct current voltage of about $U \approx 12 \div 48$ V may be a disadvantage but not an obstacle, since versions of all common electric appliances (light sources, TV sets, refrigerators, electric drills, etc.) exist for 12÷24 V input voltage. Moreover, this DC voltage can be electronically converted into standard AC voltage with $U = 230$ V. Other disadvantages, e.g. that the

serviceability of a solar power station is 30 % at best, compared to 85 % serviceability of a fossil, nuclear and hydroelectric power plants, or fluctuations of solar radiation (at night, when energy is most needed, there is none) are not serious obstacles. It is true that solar radiation is not available to order, that not all days are sunny under Central European conditions. However, long-term observations have yielded certain average values, which can be used for the calculations. The non-uniformity of solar energy supply could be counter-balanced by accumulators, either classical electrochemical or based on the energy accumulated in hydrogen gas produced by electrolysis of water. Hydrogen could then be transported in pressurised tanks or in liquid state and used in hydrogen powered combustion motors with minimum emissions, or for electric power production through controlled electrochemical reaction in so-called fuel cells. Small solar devices have one more advantage, their transportability. They are very useful for mobile applications, e.g. for nomads or for mobile scientific expeditions in remote areas. Solar photovoltaic panels are the most efficient energy sources on space stations and satellites orbiting close to Sun.

Conclusion: There is only one natural energy source – nuclear energy. The other types of energy are converted from nuclear energy. Also nuclear energy has the fundamental importance for the future. The fossil fuels will be consumed and renewable energy sources cannot cover the permanently increasing energy consumption. The energy accumulation is limited at present.

The new nuclear reactors will be constructed, especially fast reactors making the fissible isotopes. The renewable energy sources will be important component in the energy mix.

At present, the most amount of working nuclear reactors in nuclear power stations is in European Union (146), especially in France (76). 62 new reactors are constructed, especially in China (28) and Russian (10).

BIOPHYSICAL EXPERIMENTS

István Seres, Piroska Víg

Department of Physics and Process Control,
Szent István University
Páter Károly út 1., 2103 Gödöllő, Hungary
Seres.Istvan@gek.szie.hu

During the BioPhysics Spring conference serial a lot of interesting topics were introduced by the PhD students and the invited keynote speakers, but most of the time the results were presented by powerpoint (and sometimes Prezi) presentations. However there is a nice possibility for making the scientific knowledge more understandable: introducing it with experiments. The aim of the presentation is to introduce some interesting physical experiments connected to the Biophysics, and of course the interpretation of the shown phenomenon.

The Physics of the liquids and among them the Physics of the non-Newtonian liquids is an important field in the Biophysics (most of the liquids with biological content are non-Newtonian). The liquids are called Newtonian if the deformation speed (speed gradient, shear rate) of the liquid is proportional to the shear stress. If the connection is not proportional between the two quantities, then we speak about non linear liquid (Fig. 1).

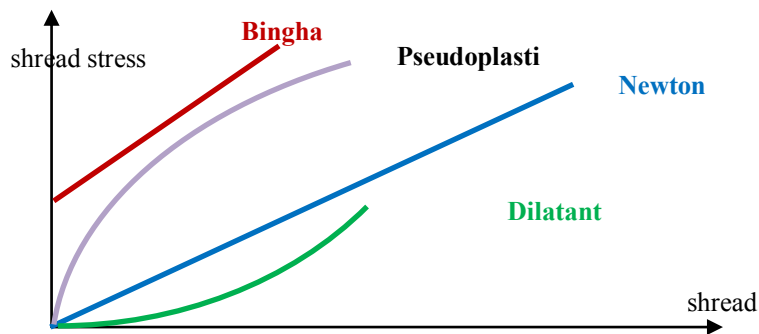

Fig. 1. Shear stress as a function speed gradient (shear rate).

The big difference between the Newtonian and non-Newtonian media, can be visualized by a few experiments. It is possible to buy some non-Newtonian plasticine – sold for children in special shops – to demonstrate this, but there is an

everyday material – the starch – with very similar properties – it is dilatant, so its viscosity is increasing with the shear stress.

With starch solution we will demonstrate this special property in some experiments, e.g. changing between fluid and solid state, “dancing” starch (Fig. 2) and even we make a bulletproof “jacket for an egg from starch.

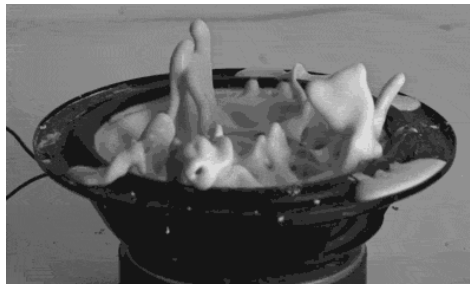

Fig. 2. Dance of starch solution on a loudspeaker.

Another field for interesting experiments is to make our eyes fool. There are very nice optical illusions, and among them we would like to introduce some when the illumination is not continuous. The so called stroboscopic effect can be recognized in the everyday life, as well. For example if someone watching a movie, and see the spokes of the wheel of a coach rotating back, while the coach is going ahead, the stroboscopic effect works.

To demonstrate it, we will make visible fast periodic motions (vibrations of a guitar string or a tuning-fork), but with this trick it is possible to set up an illusion, where the participants see the free falling water drops to fall up, instead of down. We plan to show it.

Another interesting field of the classical biophysics is the surface tension. With bubbles and other membranes we try to demonstrate the basic laws, and their biological consequences.

ACKNOWLEDGEMENTS

This work was supported by Doctoral School of Engineering, Szent István University, Gödöllő, Hungary.

REFERENCES

1. CHHABRA R. P., 2007. Bubbles, drops, and particles in non-newtonian fluids, CRC Press.
2. BRECKENRIDGE J., 1993. Simple physics experiments with everyday materials, Sterling.

SOIL WATER HYSTERESIS – THE MEASUREMENT AND MODELING

Cezary Sławiński

Department of Metrology and Modelling of Agrophysical Processes,
Institute of Agrophysics Polish Academy of Sciences
Doświadczalna 4, 20-290 Lublin, Poland
c.slawinski@ipan.lublin.pl

The soil water retention curve (SWRC) describes the relationship between water content and water potential. It characterises soil hydraulic properties and is one of the most important soil hydrophysical characteristics. This interdependency manifests hysteresis, defined as the difference between the water content of the soil and the corresponding water potential obtained under wetting and drying processes. This effect means that water content in the drying (or drainage) branch of soil water retention curve is larger than water content in the wetting branch for the same value of water potential. The hysteresis region is called hysteresis loop. The wetting and drying curves can be of the first or higher orders depends on actual soil water potential at which the wetting or drying process is started. Numerous models describing soil water hysteresis were developed. These models can be categorized into two main groups: the conceptual models and empirical models.

The soil water hysteresis can significantly influence water and solute flow processes occurred in the soil profile. It can be underlined that the hysteresis is usually neglected in water flow studies because of a lack of high quality data. Therefore it is important to elaborate and develop new devices and methods for measuring and describing this phenomenon.

The aim of this work is to review the methods of measurement and modelling of soil water hysteresis and on this background to show the methods of investigation of this phenomenon developed in the Institute of Agrophysics.

ACKNOWLEDGEMENTS

This work has been partially supported by the National Science Centre, research grant 2011/01/B/ST10/07544.

VEGETABLE OILS THERMAL PROPERTIES AND ENERGY VALUES

Vlasta Vozárová, Michal Valach, Eubomír Hřeš, Ana Petrović, Ján Csillag

Department of Physics,
Slovak University of Agriculture in Nitra
Tr. A. Hlinku 2, 949 76 Nitra, Slovakia
vlasta.vozarova@uniag.sk

Vegetable oils are components of food materials and they are also used as biodiesel (about 16 % of vegetable oils production). Edible oils and fats are composed primarily of the following components: triacylglycerols (94.4–99.1 91.8–99.0 %), phospholipids (up to 4.0 %), free fatty acids (0.3-1.8 %) and other components: unsaponifiables, tocopherols, chlorophylls, sulphur etc. (Gunstone, 2002). Vegetable oils comprise mixtures of fatty acids in proportions that depend on the source materials. These fatty acids vary with respect to carbon chain length and degree of saturation. Fatty acid composition has a major impact on the properties of the oil and thus on both food and fuel quality. Knowledge of this impact should facilitate the process of selecting oil sources for the purpose of producing either food or fuel with optimal characteristics (Hansen, A. C. – He, B. B. – Engeseth, N. J., 2011).

Thermal properties are related to heat transfer control and can be classified as thermodynamic properties (enthalpy and entropy) and heat transport properties (thermal conductivity and thermal diffusivity). According to the author (Barbarosa-Cánovas et al, 2006) thermophysical properties not only include thermodynamic and heat transport properties, but also other physical properties involved in the transfer of heat, such as freezing and boiling point, mass, density, porosity and viscosity.

The present work deals with thermal – heat transport properties of different kind of edible vegetable oils. The brief characterization of investigated material is presented – chemical composition and physical characterization. Measurement of olive oil, rapeseed oil and sunflower oil thermal conductivity and thermal diffusivity and effect of temperature on these properties in temperature interval from 10 °C to 40 °C are presented. ISOMET 2104 and hot-wire method was used for measurement (Krempaský, 1969). Obtained dependencies with regression equations are in the graphs (Figs 1 and 2). As for energy values of vegetable oils, comparative measurement of specific heat of combustion of vegetable oil samples and solid biomass is presented as well (Tab. 1). Measurement of specific heat of combustion was done by calorimeter IKA C5000.

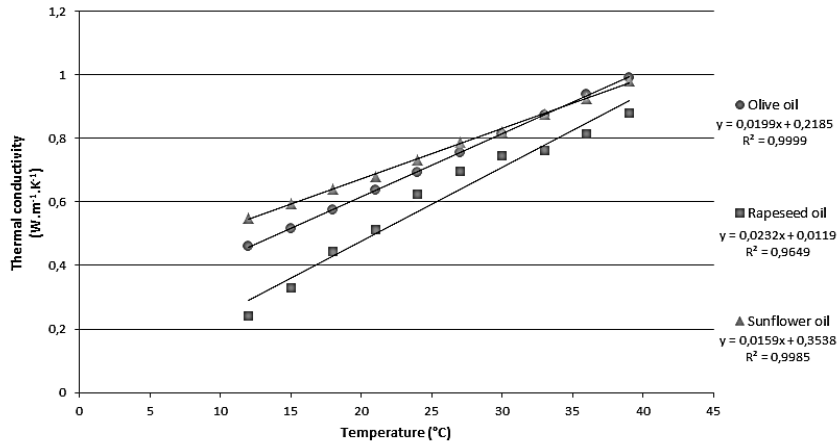

Fig.1. Relation of thermal conductivity to temperature.

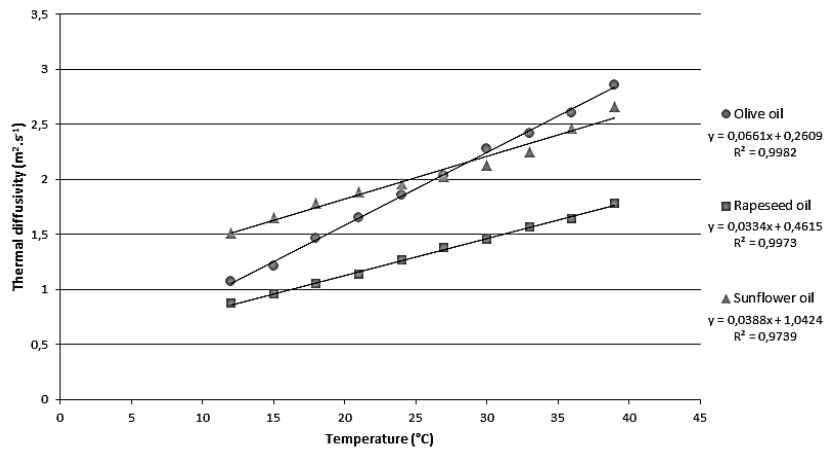

Figure 2: Relation of thermal diffusivity to temperature.

Theory and high values of determination coefficients showed that in the measured temperature interval (close to room temperatures) can be used linear regression for temperature dependency thermal conductivity and thermal diffusivity for each sample of investigated vegetable oils. We can see that slope of individual regression is different: sunflower oil thermal conductivity increase mildest with temperature and olive oils thermal diffusivity increase the most sharply.

Results of specific heat of combustion measurements show that oils have more than two times higher specific heat of combustion in comparison with samples of solid biomass (pellet and briquette).

Table 1. Specific heat of combustion:

Sample	Specific heat of combustion (J.g ⁻¹)
Olive oil	40 086
Rapeseed oil	39 433
Sunflower oil	49 364
Pellet	17 161
Briquette	19 463

Vegetable oils are used extensively in food products and food processing. Recently, attention has been focused on their use as fuel for engines and heating. Obtained values of specific heat of combustion indicate the reasons for the use of oils as fuels.

ACKNOWLEDGEMENTS

This work was co-funded by European Community under project no 26220220180: Building Research Centre „AgroBioTech“.

REFERENCES

1. GUNSTONE F.D., Ed. 2002. Vegetable Oils in Food Technology. Blackwell Publishing, 2002.
2. HANSEN A.C., HE B.B., ENGESETH N.J., 2011. Food versus Fuel Characteristics of Vegetable Oils and Animal Fats. Transactions of the ASABE Vol. 54(4): 1407-1414.
3. BARBAROSA-CÁNOVAS G.V., JULIANO P., PELEG M., 2006. Engineering Properties of Foods, EOLSS Publishers, Oxford, UK 2004/Rev.2006, <http://www.eols.net>.
4. KREMPASKÝ J., 1969. Measurement of Thermophysical Parameters (in Slovak), Slovak Academy of Sciences, Bratislava, 1969.

ORAL CONTRIBUTIONS OF YOUNG SCIENTISTS

APPLICATION OF TDR TECHNIQUE FOR DETERMINATION OF THE EFFECT OF SOIL MOISTURE ON WATER INFILTRATION FROM THE ATMOSPHERE DURING EFFECTIVE NON RAINFALL PERIODS

*Małgorzata Albert¹, Andrzej Wilczek², Grzegorz Janik¹, Wojciech Skierucha²,
Marek Błaś³, Mieczysław Sobik³*

¹Institute of Environmental Protection and Development, Wrocław University of Environmental and Life Sciences, pl. Grunwaldzki 24, 50–363 Wrocław, Poland
malgorzata.albert@up.wroc.pl, grzegorz.janik@up.wroc.pl

²Department of Metrology and Modelling of Agrophysical Processes,
Institute of Agrophysics of the Polish Academy of Sciences,
Doświadczalna 4, 20–290 Lublin, Poland
a.wilczek@ipan.lublin.pl, w.skierucha@ipan.lublin.pl

³Institute of Geography and Regional Development, Faculty of Earth and Environmental Sciences, University of Wrocław, A. Kosiby 8, 51–621 Wrocław, Poland
marek.blas@uni.wroc.pl, mieczyslaw.sobik@uni.wroc.pl

The concept of effective non rainfall water flux is defined as the volume of water that actually supplies the surface layer of soil through the formation of dew, hoarfrost, fog sediment, condensation of water vapour contained in soil air, and adsorption of water from the atmosphere. The method, permitting highly precise quantitative description of the process, makes use of TDR sensors and aluminium barriers, impermeable to water, placed beneath soil surface (Janik *et al.*, 2014). The advantage of the method is that the only values that have to be determined are the moisture and temperature of the top layer of soil. We can distinguish 3 groups of factors affecting the intensity of effective non rainfall water flux. The first includes climatic factors such as air temperature and relative humidity, solar radiation or wind velocity. The second includes physiographic factors, e.g. land relief. The third group is made up of the entirety of soil factors. The objective of this study was to elaborate a relation illustrating the effect of moisture of the top layer of soil on the effective non rainfall water flux. For the realization of that objective a pilot experiment was conducted, the schematic of which is presented in Fig. 1.

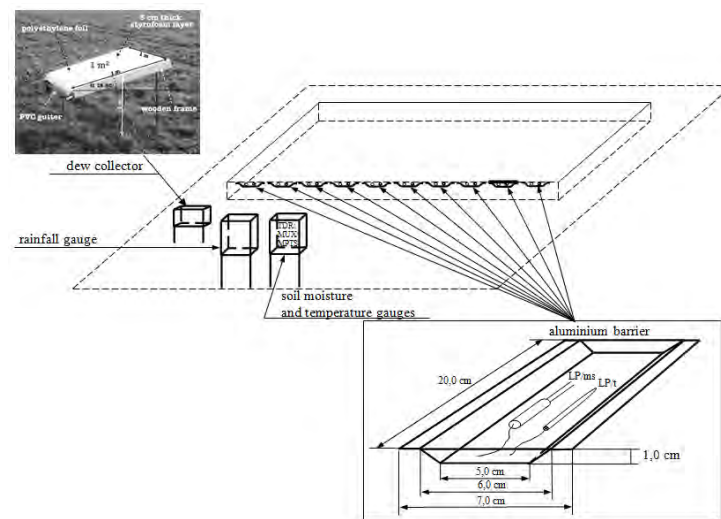

Fig. 1. Schematic of the experiment.

The first step on the experiment was the installation, in the top layer of soil, of 28 aluminium barriers separating the undisturbed structure of the monolith. Next, miniature sensors were installed – volumetric moisture sensors (sensors LP/ms) and temperature sensors (sensors LP/T). Volumetric moisture content was recorded at 10 min intervals for a period of 2 months. Also recorded was the diurnal intensity of deposit on the dew collector. The experimental sites were irrigated at various rates, to achieve varied levels of current moisture of the soil. The experiment was conducted in the area of the meteorological observatory of the Department of Climatology and Atmosphere Protection, University of Wrocław.

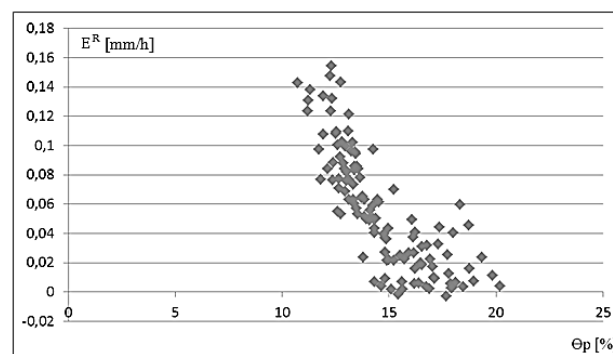

Fig. 2: Relation of soil water absorption capacity to its initial moisture; E^R – effective non rainfall water flux, θ_p – moisture.

Figure 2 presents a point cloud illustrating the relation of soil water absorption capacity to its initial moisture.

REFERENCES

1. JANIK G., SKIERUCHA W., MAREK M., SOBIK M., ALBERT M., DUBICKI M., ZAWADA A., 2014. TDR technique for estimating the intensity of effective non rainfall. *International Agrophysics*, 28(1), 23–37.

THE EFFECT OF ADDITION OF ZEOLITE ON CHANGES IN SURFACE CHARGE OF SELECTED SOILS

*Anna Ambrożewicz-Nita, Grzegorz Józefaciuk, Justyna Szerement,
Justyna Piasek, Karolina Kędziora*

Department of Physicochemistry of Agricultural Materials
Institute of Agrophysics Polish Academy of Sciences
Doświadczalna 4, 20-290 Lublin, Poland
a.ambrozewicz-nita@ipan.lublin.pl

Zeolites are natural aluminosilicates composed of AlO_4 and SiO_4 tetrahedra arranged into ordered crystallographic network. They were formed after volcanic ash settling in ancient alkaline lakes.

Zeolites have been widely used in agriculture (Reháková et al. 2004), microelectronics, optics, medicine, environmental protection and chemical industry. In agriculture zeolites are used as fertilizers, feed additives and soil conditioners. One of the main advantages of a zeolite is a high sorption capacity and its ability to bind cationic nutrients and water molecules (Mansouri et al. 2013). As a result, zeolites prevent the elution of the nutrients from the soil, thereby increasing their availability to the plants as well as increase water retention in the soil during periods of drought. Furthermore zeolites have a storage capacity for gases (eg. air) and have a positive effect on soil ventilation.

Potentiometric titration method enables estimation of surface charge amount as well as determination of distribution function of the apparent dissociation constants of surface charge generating functional groups (Dubach et al. Ephraim et al. 199, Kohler et al. 2002, Maes et al. 1999, Matyka-Sarzyńska et al. 2000, Sposito et al. 1979).

The aim of this study was to determine the effect of different doses of zeolite on surface charge of the two soils – black earth and brown soil formed from loess using back-titration method according to the procedure described

in Matyka-Sarzyńska et al. 2000. The experimental apparatus Titrino provided by Mettler Toledo equipped with Orion combined electrode was applied for titration.

The results of the experiments are presented in Table 1.

Table 1. Surface charge (CEC) and average surface dissociation constants (aK_{ppav}) of the studied soils before and after zeolite addition:

Black earth			Brown soil formed from loess		
Dose of zeolite	CEC	aK_{ppav}	Dose of zeolite	CEC	aK_{ppav}
0%	20.5	7.14	0%	13.46	7.94
1%	18.46	7.22	1%	12.46	6.53
5%	29.53	6.27	5%	14.42	6.26
10%	29.01	7.35	10%	22.1	7.04
20%	29.93	7.48	20%	24.6	7.84
40%	42.6	6.88	40%	41.20	6.76

The zeolite addition increased surface charge of all soils, however it was not proportional to the amount of zeolite dose

ACKNOWLEDGEMENTS

This research was financed by the Project No IPBU.01.01.00-06-570/11-00 Developing an innovative model of the cross-border use of zeolitic tuff.

REFERENCES

1. REHÁKOVÁ M., ČUVANOVÁ S., DZIVÁK M., RIMÁR J., GAVAL'OVÁ Z. 2004. Agricultural and agrochemical uses of natural zeolite of the clinoptilolite type. *Current Opinion in Solid State and Materials Scienc* p. 379404.
2. MANSOURI A., RIKHTEGAR N., PANAHI H.A., ATABI F., SHAHRAKI B. 2013. Porosity, characterization and structural properties of natural zeolite – clinoptilolite – as a sorbent. *Environment Protection Engineering* : 39 (No.1).
3. DUBACH, P. - METHA, N.C. - JACAB, T. - MARTIN, F. and ROUTLET, N. - 1964. Chemical investigations on soil humic substances. *Geochim. Cosmochim. Acta*, 28, p.1567-1578.
4. MATYKA-SARZYŃSKA D., SOKOŁOWSKA Z., JÓZEFACIUK G., 2000. Variable surface charge of selected peat materials as determined from back titration. *Acta Agrophysica*, 26, p. 51-58.

SOLAR AND BIO HYDROGEN PRODUCTION USED FOR FUEL CELLS ENERGY CONVERSION SYSTEM

Sándor Bartha¹, Viorel Ursu¹, Noémi Antal²

¹ICPE-Institute for Electrical Research
030138 Bucharest, Romania Splaiul Unirii 313
sbartha@freemail.hu, vio@icpe.ro
Faculty of Environmental Science and Engineering Extension
²University Babeş Bolyai, Cluj- Napoca,
Sf. Gheorghe, 520050 Sf. Gheorghe , Stadionului Nr. 14.
antalnoemi@yahoo.com

One of the challenge of the 21 century is to is to supply the world population which arrived recently nearly 7 billion people, with energy, from statistical dates the actually energy consumption is 15 TW, witch from predictive dates in 2050 can be doubled an the world population arrived 9bilion people. This growing energy consumption can be insure with helpful of the renewable energy sources. Another challenge is the CO₂ emission reduction that can be realised by reducing the dependence from the fossil fuels. Al of this can be arrived with implementing of the sustainable energy sources in the global energy market. Base on statistical dates and predictive models the solar energy is only source that has the potential to meet all energy needs of these growing trends. To generate 20 TW of power from the sun is necessary the 816.000 km² area to be covered with PV modules. (Gratzel, M, 2011, Lewis 2006). This energy production concept can be not realised because the intermittent nature of the solar power can be produced difficult problems for network operators and the produced energy can be stored in high performance and large scale storage capacity that make an important increasing process of the electricity price. On way to resolve these problems is to change the economy based on fossil fuels to hydrogen. On important sources for hydrogen is the water that is a convenient and abundant hydrogen resource. If the world energy consumption will be made from hydrogen that can be insure from 3.5 x10¹³ l water. This corresponds to 0.01 % of the annual rain fall or 0.000002% of the amount of water in world oceans. The water splitting reaction can be written as fallow:

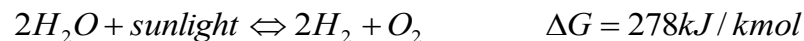

The paper presents same aspect of the hydrogen technology production, one of this is the hydrogen production technology by electrolysis, ideally 39 kWh of electricity and 8.9 l water are required to produce 1 kg of hydrogen at 25 °C and 1 atmosphere pressure. The typical commercial electrolyser with 56-73 % efficiency can produced 1 kg hydrogen with 53-78 kWh energy required (Rajeswar et al., 2011).

In this paper we will present one hydrogen production technology for laboratory application where the electrolyser is connected to one Photovoltaic energy conversion system. The produced hydrogen is stored in one metal hybrid unit that are “Ovonic” trade mark, that stored the produced hydrogen is solid form. The used equipment is presented in the following figures fig 1. In this figures we will be indicated the principal technical parameters of the equipment and the internal structure of the hydrogen solid form storage that has 125 g/l storage density.



Fig. 1: The equipment structure for the hydrogen production and storage technology connected to Photovoltaic solar energy conversion system

The paper presents the energy and mass balance of this equipment and indicated the energy producing process helpful of fuel cells application, the used fuel cells in this conversion is a PEM fuel cell with 350Wp, rated power. The experimental results is also are presented. The final part of the article is indicated other fuel cells technologies (O’HAYRE, R, 2009) used in industrial application, like “Direct liquid Fuel cells”, that are running with methanol based the following chemical process:

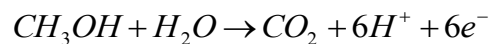

The used methanol is produced by biotechnological process from different biomass raw materials and wastes resulted from biomass. The paper treats these technological issues.

REFERENCES

1. BARTHA S., D.I.TEODOREANU I., FARKAS M., TEODOREANU, 2011. Solar Photovoltaic Fuel Cell Conversion System for Electricity Generation, Revista Electrotehnica, Electronica, Automatica, Vol. 59 , Nr. 2., p. 69-75.
2. LEWIS N.S., NOCERA D.G. 2006. Powering the planet: chemical challenges in solar energy utilization. Proc. Nat. Acad. Sci. U S A 103, 15729–15735.
3. O'HAYRE,R. WON CHA S., COELLA W., PRINZ F.B, 2009. Fuel Cells Fundamentals Wiley p.282-285.
4. RAJESHWAR R., Mc CONEL L, LICHT S. 2011. Solar Hydrogen Generation, Toward a Renewable Energy Future, Springer p. 43-63.
5. ROEL VAN DER KROL-GRATZEL M. 2011. Photo electrochemical Hydrogen Production Springer, p. 4-12.

PHOSPHORUS AND SULFUR UTILIZATION PROFILES OF TWO HEAT-RESISTANT STRAINS OF *Neosartorya fischeri* USING PHENOTYPE MICROARRAY (PM PLATES)

Nina Bilińska, Magdalena Frąc

Department of Soil and Plant System,
Institute of Agrophysics Polish Academy of Sciences
Doświadczalna 4, 20-290 Lublin, Poland
n.bilinska@ipan.lublin.pl, m.frac@ipan.lublin.pl

Neosartorya fischeri is a commonly isolated species from heat-processed fruit-based products. Molds are known to produce mycotoxins during their growth and therefore pose a hazard to human health. A necessary condition for reducing the negative effects of *Neosartorya fischeri* occurrence in fruit products is to understand its requirements for growth. The aim of the presented study was to evaluate utilization profiles of phosphorus and sulphur sources of *N. fischeri* strains.

The phenotype microarray system (PMs) was used to collect information on phosphorus and sulphur utilization profiles of *Neosartorya fischeri*. The PMs was

used to evaluate capability of sources utilization of two *Neosartorya fischeri* strains: reference (DSM 3700) and environmental (G48_12).

DSM 3700 strain, coming from canned apples, was purchased from DSMZ (Braunschweig, Germany). G48_12 was isolated in The Laboratory of Molecular and Environmental Microbiology, Institute of Agrophysics PAS (GenBank: KC179765). The strain was isolated from a strawberry product and identified as *N. fischeri* (Frąc et al., 2012) on the basis of a large subunit ribosomal RNA gene partial sequence. *N. fischeri* strains were cultured for 14 days in the dark at 27°C on PDA medium.

Substrate utilization screening of *N. fischeri* strains was analyzed following the OmniLog Phenotype MicroArray technology provided by Biolog (Biolog, Inc., Hayward, CA). Phosphorus and sulphur assimilation profiles were evaluated using PM4 MicroPlate. MicroPlate contains 96 wells including 59 different phosphorus sources and 35 sulphur sources. After inoculation PM MicroPlates were incubated in OmniLOG at 26°C for 96 hours. The Phenotype MicroArray (PM) software was used to analyze the results.

The most intensively utilized phosphorus substrates by the environmental strain were: Adenosine-5'-Monophosphate, Adenosine-2'-Monophosphate, Adenosine -3'5'-Cyclic Monophosphate. Adenosine-3'-Monophosphate, Adenosine -2'3'-Cyclic Monophosphate, Guanosine-3'5'-Cyclic Monophosphate have been used by both strains but much more actively by the reference strain. The most frequently used sulphur sources by G48_12 strain were as follows: L-Cysteine Sulphinic Acid, L-Methionine Sulphoxide, Methane Sulphonic Acid and Thiourea. N-Acetyl-D,L-Methionine, 2-Hydroxyethane Sulphonic Acid, p-Amino Benzene Sulphonic Acid, N-Acetyl-L-Cysteine strains have been used by both strains.

The environmental strain revealed much wider capabilities of using substrates located on Biolog plate, than the reference strain in both phosphorus and sulphur sources. G48_12 strain utilized almost all sources of phosphorus and sulphur whereas the reference strain was able to utilize less than half of phosphorus sources and one third of the sulphur source.

ACKNOWLEDGEMENTS

The study was supported by National Science Centre (Poland), grant: DEC-2012/07/D/NZ9/03357.

AGENTS FOR CHELATE-ASSISTED PHYTOEXTRACTION

Piotr Bulak, Małgorzata Brzezińska

Department of Natural Environment Biogeochemistry,
Institute of Agrophysics Polish Academy of Sciences
Doświadczalna 4, 20-290 Lublin, Poland
pbulak@ipan.lublin.pl

Phytoextraction, among others technics like phytostabilization, phytohydraulic control and rhizofiltration, is a form of phytoremediation (Bulak et al. 2014). Phytoremediation technics are quickly developing and can be applied to contaminations such as heavy metals, metalloids and radionuclides, allows theoretically to clean-up even whole contamination pool from the soil (Padmavathiamma and Li 2007). In the process of continuous phytoextraction specialized plants (with natural hyperaccumulation abilities) are used to remove contaminants from soils. Plants hyperaccumulate trace elements through their roots and store them into the upper tissues. The contaminants are removed when the plants are harvested (Evangelou et al. 2007). In the contrary to continuous phytoextraction the use of chelate-assisted method enable to force the plants to increase their hyperaccumulation abilities (Evangelou et al. 2007). Phytoextraction has a good public acceptance and it is also more economical than traditional methods for soil treatment (Barbafieri and Tassi 2011).

Chelate-assisted phytoextraction

There are two major class of chelate agents used in this purpose. The most commonly used substance in the group of synthetic aminopolycarboxylic acids (APCAs) is EDTA (ethylene diamine tetraacetic acid). The enhanced uptake of heavy metals by the addition of EDTA depends on the exact heavy metal and plant species (Evangelou et al. 2007). Despite the fact that EDTA is considered to be very effective in enhancing phytoextraction, it is also known that EDTA and EDTA-heavy metal complexes are harmful to plants decreasing shoot biomass. This compound show also toxicity to soil microbiota. Due to EDTA is non-biodegradable and may occur in soil even after soil cleaning there is also risk of leaching the metals to groundwater. (Evangelou et al. 2007). Besides EDTA, there are also another synthetic ACPAs: HEDTA (hydroxyethylene diamine tetraacetic acid), DTPA (diethylene triamino pentaacetic acid), CDTA (trans-1,2-cyclohexylene dinitrilo tetraacetic acid), EGTA (ethylene bis[oxyethylenetrinitrilo] tetraacetic acid), EDDHA (ethylenediamine-N,N'bis(o-hydroxyphenyl)acetic acid), HEIDA (N-(2-hydroxyethyl)iminodiacetic acid) and HBED (N,N'-di(2-hydroxybenzyl) ethylene diamine N,N'-diacetic acid

(Evangelou et al. 2007). Studies show that combination of EDTA and EDDS is very efficient in the process of phytoextraction (Padmavathiamma and Li 2007). The second class of chelate compounds are natural low molecular mass organic acids (NLMMOAs). Citric, malic or oxalic acids are constituents of roots exudates. NLMMOAs are completely and rapidly biodegradable. They also makes continuous use possible (Evangelou et al. 2007). In the case of some metals (e.g. U) the use of NLMMOAs gives significantly better results than the use of synthetic chelators, whereas with other metals (e.g. Pb), the efficiency is low (Huang et al. 1998, Evangelou et al. 2006).

REFERENCES

1. BARBAFIERI M., TASSI E., Brassinosteroids for phytoremediation application. - In: HAYAT, S. – AHMAD, A. (Eds.) Brassinosteroids: A class of plant hormone. Springer Science+Business Media B. V. 2001, p. 403–437.
2. BULAK P., WALKIEWICZ A., BRZEZIŃSKA M., 2014. Plant growth regulators-assisted phytoextraction. *Biologia Plantarum*, 58, p. 1–8.
3. EVANGELOU M.H.W., EBEL M., SCHAEFFER A., 2006. Evaluation of the effect of small organic acids on phytoextraction of Cu and Pb soil with tobacco *Nicotiana tabacum*. *Chemosphere*, 63, p. 996–1004.
4. EVANGELOU M.W.H., EBEL M., SCHAEFFER A., 2007. Chelate assisted phytoextraction of heavy metals from soil. Effect, mechanism, toxicity, and fate of chelating agents. *Chemosphere*, 68, p. 989–1003.
5. HUANG J.W., BLAYLOCK M.J., KAPULNIK Y., ENSLEY B.D., 1998. Phytoremediation of uranium contaminated soils: role of organic acids in triggering uranium hyperaccumulation in plants. - *Environmental Science & Technology*, 32, p. 2004–2008.
6. PADMAVATHIAMMA P. K., LI L.Y., 2007. Phytoremediation technology: hyperaccumulation metals in plants. *Water Air Soil Pollution*, 184, p. 105–126.

THE PREFERENTIAL FLOW OF WATER IN DIFFERENT SOIL COMPACTION AND TILLAGE TYPES

Jan Chyba, Milan Kroulik

Department of Agricultural Machines,
Czech University of Life Sciences Prague
Kamýcká 129, 165 21 Prague, Czech Republic
chyba@tf.czu.cz

Agricultural machinery is an integral part of modern agriculture; however, it brings adverse effect on soil compaction. The soil compaction affects soil physical properties; for example increases soil bulk density which leads to a reduction of soil water infiltration rate. Combination of these adverse effects leads to soil erosion and may affect overall crop yields. In order to identify and characterize mechanisms and preferential flow of water in the soil, dye tracers are used. The dye tracers can help in tracking and quantifying the transfer of water and the chemicals in the soil (Weiler, 2005), as through monitoring of preferential flow (Alaoui et al., 2008) of water, penetration of harmful substances through the surface of the soil into groundwater may be predicted (Öhrström et al., 2004). Dye tracers can also be used to measure one dimensional values of the average dye concentration against depth. Different dye coverage on the soil surface can be explained by plant material, soil structure on the surface and water retention (Mooney et al., 2008).

To describe water preferential flow the brilliant blue dye tracer was used. This method showed an influence of field trafficking by agricultural machinery and soil tillage on water preferential flow. For brilliant blue dye tracing (infiltration) a 0.3 % solution of E133 brilliant blue FCF colorant was prepared in water. First, the solution was poured in 10 litres per 1 m² of surface of the soil by watering can with diffuser. The solution was poured gradually and slowly so as to avoid surface runoff and all of the solution was absorbed by soil. For the measurement is also possible to use the frame defining the area of application. Then, after a period of 24 hours the hole was excavated so that it was possible to take photos of vertical slices of the soil profile. The photographed area was always bounded by frame (0.4 x 0.6 m) with gauges which allows subsequent evaluation. Images were then processed by software BMPTools (Anken et al., 2004), which divides the soil background and brilliant blue solution in two different colours. One of the colours represents the brilliant blue solution which shows percentage of infiltrated brilliant blue dye for known area. In this case the image was divided into several horizontal images (each represented one depth range) and then they were

processed by BMPTools software which calculated the percentage of blue colour on the image. Measurements were performed on soil type *Hapalic Luvisoil* with shares fractions: dust 41.4 %, clay 46.3 %, fine sand 7.9 % and sand 4.4 %. Location falls within the slightly warm, slightly dry, with mostly mild winter. Measurement main variants were plowing and CTF. Measurement sub-variants were: with (depth of 0.45 m) and without deep loosening three years before measurement, inside and outside of the tires footprints.

The results showed the highest concentration of brilliant blue dye tracer outside of the traffic lines without deep loosening than for outside of the traffic lines with deep loosening. The lowest concentration of brilliant blue dye tracer was observed inside of the traffic lines. Table 1 shows test of homogenous groups. There were no statistical significant differences between tillage variants with one exception. This exception was with the deep loosening which reduced the brilliant blue dye tracer coverage in the case of variants measured outside of the traffic lines, on the other hand slightly increases the coverage in the case of variants measured inside of the traffic lines (see Figure 1).

In conclusion the main effect which prevents the flow of water through the soil is the soil compaction. Also tillage affects the preferential flow of water in the soil; while the largest influence, from the observed variant, had a deep loosening. Dye tracer showed the best results for plowing and CTF than for plowing with deep loosening and CTF with deep loosening. Dye tracer is a valuable method for monitoring the impact of agro-technical processes on soil infiltration properties and preferential flow of water.

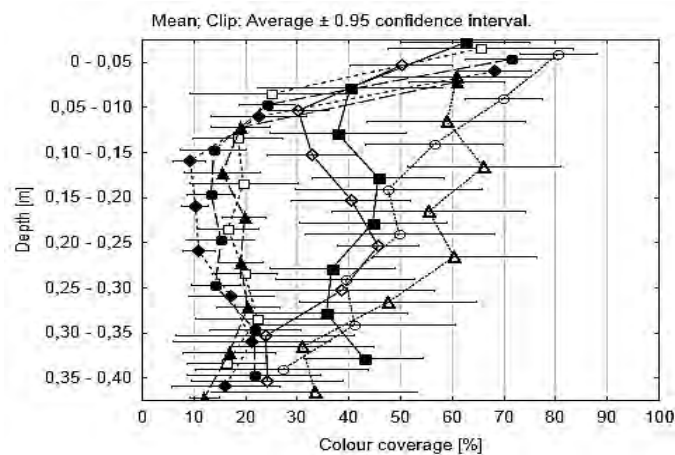

Fig.1. Relationship between coloured surface and soil depth.

Plowing O-DL,
 Plowing I-DL,
 Plowing O,
 Plowing I,
 CTF O-DL,
 CTF I-DL,
 DL,
 CTF O,
 C

Table 1. Tukey's HSD test of homogenous groups:

a, b ... – homogenous groups in the row; 1, 2 ... – homogenous groups in the column

I – inside the traffic lines; O – outside the traffic lines; DL – deep loosening

Depth [m]	CTF O	CTF O-DL	CTF I	CTF I-DL	Plowing O	Plowing O-DL	Plowing I	Plowing I-DL
0 – 0.05	a,b	a	a,b	a,b,c	c	a,b,c	b,c	a,b,c
	1	1	1	1	1	1	1	1
0.05 – 0.10	c,d	a,b	a	a,b	d	b,c	a,b	a,b
	1,2	1,2	2	2	1,2	1,2	2	2
0.10 – 0.15	c	b	a	a	c	b	a	a
	1	1,2	2	2	1,2,3	2	2	2
0.15 – 0.20	b	b	a	a	b	b	a	a
	1,2,3	1,2	2	2	2,3,4	1,2	2	2
0.20 – 0.25	b	b	a	a	b	b	a	a
	1,2	1	2	2	2,3,4	1,2	2	2
0.25 – 0.30	d	b,c,d	a,b,c	a	c,d	b,c,d	a	a,b
	1,2,3	1,2	2	2	3,4	2	2	2
0.30 – 0.35	a,b	a,b	a	a,b	b	a,b	a,b	a,b
	3	2	2	2	3,4	2	2	2
0.35 – 0.40	a,b	a,b	a	a	a,b	b	a,b	a
	2,3	2	2	2	4	1,2	2	2

REFERENCES

1. ALAOUI A., GOETZ B., 2008. Dye tracer and infiltration experiments to investigate macropore flow. *Geoderma*, 144 (1-2), p. 279–286.
2. ANKEN T., WEISSKOPF P., ZIHLMANN U., FORRER H., JANSKA J., PERHACOVA K., 2004. Long-term tillage system effects under moist cool conditions in Switzerland. *Soil and Tillage Research*, 78 (2), p. 171–183.
3. MOONEY S. J., MORRIS C., 2008. Amorphological approach to understanding preferential flow using image analysis with dye tracers and X-ray Computed Tomography. *Catena*, 73 (2), p. 204–211.
4. ÖHRSTRÖM P., HAMED Y., PERSSON M., BERNDTSSON R., 2004. Characterizing unsaturated solute transport by simultaneous use of dye and bromide. *Journal of Hydrology*, 289 (1-4), p. 23–35.
5. WEILER M., 2005. An infiltration model based on flow variability in macropores: development, sensitivity analysis and applications. *Journal of Hydrology*, 310 (1-4), p. 294–315.

CLASSIFICATION OF DIETARY FIBER FRACTIONS FROM DIFFERENT SOURCES BASED ON FT IR AND HIERARCHICAL CLUSTER ANALYSIS

Monika Chylińska, Monika Szymańska-Chargot, Artur Zdunek

Department of Microstructure and Mechanics of Biomaterials
Institute of Agrophysics Polish Academy of Sciences
Doświadczalna 4, 20-290 Lublin, Poland
m.chylinska@ipan.lublin.pl

The plant cell wall is a dynamic structure composed mostly of polysaccharides with high molecular weight. The primary plant cell wall polysaccharides – cellulose, hemicellulose and pectins are a part of dietary fiber. Non-polysaccharide components of the secondary plant cell wall – lignin, cutin, waxes, suberin are also included in the dietary fiber (M-A Ha, 2000).

Nowadays fresh fruit have become an important part of the diet of people all over the world as the significant source of water, vitamins, natural sugars and above all - the dietary fiber (Zhiguo Li, 2013).

The aim of this study was to identify chemical and spectral differences between fruit cell wall samples with the use of FT IR information in combination with HCA. Dietary fiber fractions from different sources, their similarities and differences were investigated. Qualitative and quantitative analysis of materials rich in dietary fiber were performed.

In the experiment 5 species of fruit were investigated: apple, cherry, currant, strawberry and sweetcherry. The cell wall material (CWM) – total dietary fiber – from every fruit was obtained. Next the modified Van Soest's method (Van Soest, 1963) was used for NDF (neutral detergent fiber) and ADF (acidic detergent fiber) fractions obtaining. CWM contains pectins, hemicellulose and cellulose, NDF contains hemicellulose and cellulose while ADF contains only cellulose. FT IR spectra of CWM, NDF residue and ADF residue were collected (Nicolet 6700 FT-IR spectrometer Thermo Scientific, Waltham, MA, USA) and a hierarchical cluster analysis (HCA) on a data set was performed using Unscrambler 10.1 (Camo Software AS., Norway).

Fig. 1A shows FT IR spectra of cell wall material extracted from investigated fruits while Fig. 1B shows the results of cluster analysis. Dendrogram allows to trace the similarity between the individual samples. 12 "smallest" clusters (marked in Fig. 1B with the symbol "{"), were obtained. These clusters correspond to the spectra of the individual fractions of fiber extracted from apple, cherry, currant, strawberry and sweet cherry. There were also

received the 3 main "large" clusters (marked in Figure 1B with gray loop), corresponding to fractions CWM, NDF and ADF for cherry, currant, strawberry and sweet cherry. Only the results for apple fruit were not classified in the same way as for other fruits.

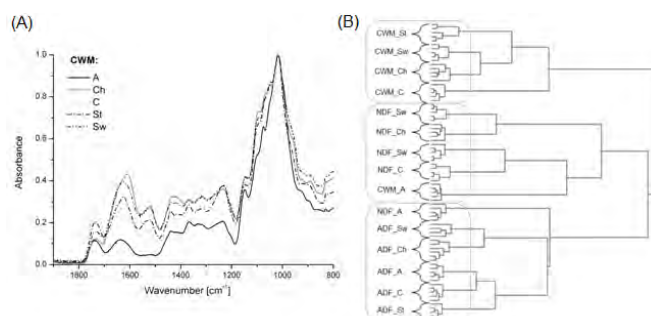

Fig.1. (A) FT IR spectra of cell wall material extracted from fruits in the range of 1,900–800 cm^{-1} ; (B) HCA dendrogram for FT IR spectra (Ward's method, Euclidean distance, range: 1,800-650 cm^{-1} , 1st derivative of spectra). Abbreviations: CWM – cell wall material, NDF – neutral detergent fiber, ADF – acidic detergent fiber; A – apple, Ch – cherry, C – currant, St – strawberry, Sw – sweetcherry.

Despite the high similarities in the composition of the studied materials, the analysis of infrared spectra and the use of multivariate statistical methods can distinguish and classify the different fractions of fibre (CWM, NDF, ADF). Based on these data, the source of dietary fibre can be also identified.

ACKNOWLEDGEMENTS

This work was co-funded by National Science Center Poland (NCN 2011/01/D/NZ9/02494).

REFERENCES

1. M-A HA, MC JARVIS, JI MANN., 2000. Review: A definition for dietary fiber. *Journal of Clinical Nutrition*, 54, p. 861-864.
2. ZHIGUO LI, HONGLING YANG, PINGPING LI, JIZHAN L., JIZHANG W., YUNFENG XU., 2013. Fruit biomechanics based on anatomy: a review. *International Agrophysics*, 27, p. 97-106.
3. P.J. VAN SOEST. 1963. Use of detergents n the analysis of fibrous feeds. II. A rapid method for determination of fiber and lignin. *Journal of the Association of Official Analytical Chemists*, 46, p. 155-160.

GEOMETRICAL FACTOR AND ITS UNCERTAINTY IN A FORMULA FOR ELECTRICAL CONDUCTIVITY

Štefan Csáki, Igor Štubňa, Viera Trnovcová, Libor Vozár

Department of Physics,
Constantine the Philosopher University,
A. Hlinku 1, 949 74 Nitra, Slovakia; istubna@ukf.sk

The investigation of firing of silicate ceramic samples by measuring electrical conductivity during linear heating is a convenient method which can be a supplement to standard methods such as TGA, DTA, TDA and others. Thermoelectrometry [MCN], which is an experimental study of the electrical conductivity in a broad temperature range, gives interesting and useful information about behavior of ceramic materials from the point of view of electrical properties. For such materials as clays, electrodes with reliable electrical contacts are crucial for measurements of electrical properties.

The goal of this contribution is determination of the geometrical factor in the formula for calculation of the DC or AC conductivity of green samples prepared from kaolin, illite and raw mixtures based on these minerals. A description of the uncertainty analysis is also given.

The sample has a prismatic form $10 \times 10 \times 20$ mm and two platinum wires ($\varnothing 0.5$ mm) serve as electrodes. The distance between them is $a = 3$ mm, and their overlap is $b = 15$ mm, see Fig. 1. Such an arrangement is chosen in order to minimize the surface electric current of the sample.

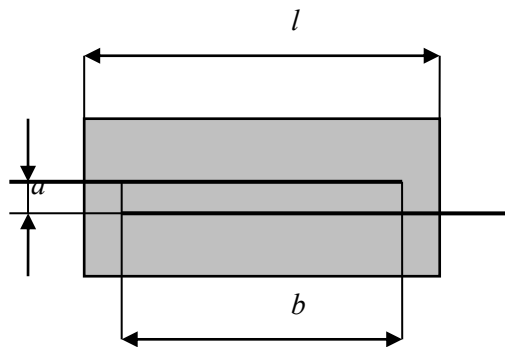

Fig. 1. The sample with electrodes, the view on the central section.

Contrary to the planar (rectangular) electrodes, where a resistance of the sample is simply

$$R_1 = d / (\sigma S), \quad (1)$$

we do not have an exact formula for the electrode arrangement depicted in Fig. 1. In Eq. (1), the symbols are as follows: σ = conductivity [$\Omega^{-1}\text{m}^{-1}$], d = distance between the electrodes [m] and S = area of the electrode [m^2]. The resistance of the sample with the wire electrodes in Fig. 1 can be written as

$$R_2 = \beta / \sigma, \quad (2)$$

where β is a function of the dimensions of the sample and positions of the electrodes.

The resistancies R_1 and R_2 were measured with V-A method [1] using a simple scheme, where we used RC oscillator Hameg HM 8030-6, digital multimeter Hameg HM 8012 as a voltmeter and digital multimeter Fluke 289 as an ammeter. We used an AC current with a frequency 50 Hz to avoid electrolysis phenomena at electrodes. The geometrical factor in Eq. (2) can be derived from a comparison of the conductivities measured on samples with planar electrodes and wire electrodes. We have

$$\beta = \frac{U_2 I_1}{U_1 I_2} \frac{d}{c_1 c_2}, \quad (3)$$

where $S = c_1 c_2$ is area of the rectangular planar electrodes. The main value of β is 12.85 m^{-1} .

We performed the uncertainty analysis [2] on 5 samples with planar electrodes and on 5 samples made in accordance with Fig. 1. The samples were prepared to be as identical as possible. List of uncertainties is in Tab. 1. The sum of A-type uncertainties of the geometrical factor is 0.256 m^{-1} and the sum of B-type uncertainties is 0.135 m^{-1} . The expanded uncertainty is 0.580 m^{-1} , i.e. the relative expanded uncertainty is 4.5 %.

Table 1. List of uncertainties

	Uncertainty source	Type	Sensitivity coefficient A	Uncertainty. $u(x)$	$Au(x)$ [m^{-1}]
	Repeatability of d	A	$1780 m^{-2}$	$5.99 \times 10^{-5} m$	0.11
	Repeatability of c_1	A	$945 m^{-2}$	$1.40 \times 10^{-5} m$	-1.32×10^{-2}
	Repeatability of c_2	A	$-582 m^{-2}$	$1.34 \times 10^{-5} m$	-7.80×10^{-3}
	Repeatability of U_1	A	$-2.07 m^{-1} V^{-1}$	$4.28 \times 10^{-3} V$	-8.86×10^{-3}
	Repeatability of U_2	A	$2.10 m^{-1} V^{-1}$	$5.00 \times 10^{-3} V$	1.05×10^{-2}
	Repeatability of I_1	A	$2856 m^{-1} A^{-1}$	$6.40 \times 10^{-5} A$	0.183
	Repeatability of I_2	A	$-1522 m^{-1} A^{-1}$	$9.21 \times 10^{-5} A$	-0.140
	The sum of the A-type uncertainties, Eq. (14)				0.256
	Caliper, MAE = $1 \times 10^{-5} m$ $u_B(d) = 1 \times 10^{-5} / \sqrt{3}$	B	$1780 m^{-2}$	$5.77 \times 10^{-5} m$	0.103
	Caliper, MAE = $1 \times 10^{-5} m$ $u_B(c_1) = 1 \times 10^{-5} / \sqrt{3}$	B	$-945 m^{-2}$	$5.77 \times 10^{-5} m$	-5.45×10^{-2}
0	Caliper, MAE = $1 \times 10^{-5} m$ $u_B(c_2) = 1 \times 10^{-5} / \sqrt{3}$	B	$-582 m^{-2}$	$5.77 \times 10^{-5} m$	-3.36×10^{-2}
1	$\sqrt{2}A(c_1)A(c_2)u_B(c_1)u_B(c_2)$	B	-	-	6.05×10^{-2}
2	V-meter, MAE = $1 \times 10^{-5} V$ $u_B(U_1) = 1 \times 10^{-5} / \sqrt{3}$	B	$-2.07 m^{-1} V^{-1}$	$5.77 \times 10^{-5} V$	-1.19×10^{-4}
3	V-meter, MAE = $1 \times 10^{-5} V$ $u_B(U_2) = 1 \times 10^{-5} / \sqrt{3}$	B	$2.10 m^{-1} V^{-1}$	$5.77 \times 10^{-5} V$	1.21×10^{-4}
4	A-meter, MAE = $1 \times 10^{-8} A$ $u_B(I_1) = 1 \times 10^{-8} / \sqrt{3}$	B	$2856 m^{-1} A^{-1}$	$5.77 \times 10^{-8} A$	1.65×10^{-4}
5	A-meter, MAE = $1 \times 10^{-8} A$ $u_B(I_2) = 1 \times 10^{-8} / \sqrt{3}$	B	$-1522 m^{-1} A^{-1}$	$5.77 \times 10^{-8} A$	-8.78×10^{-5}
	The sum of the B-type uncertainties, Eq. (15)				0.135
	The combined uncertainty, Eq. (16)				0.290
	The expanded uncertainty				0.580

REFERENCES

1. BLUMENTHAL RN., SEITZ MA. Experimental techniques. In: Electrical conductivity in ceramics and glass, part A. Edited by N.M. Tallan, Marcel Dekker Inc., New York 1974.
2. Evaluation of measurement data — Guide to the expression of uncertainty in measurement. Joint Committee for Guides in Metrology, Sévres Cedex 2010.

DETERMINATION OF CALCIUM, MAGNESIUM AND POTASSIUM IN FAWN SOIL WITH BIOCHAR BY ATOMIC ABSORPTION SPECTROSCOPY

Marta Cybulak

Department of Physicochemistry of Agricultural Materials
Institute of Agrophysics Polish Academy of Sciences
Doświadczalna str 4, 20-290 Lublin, Poland
m.cybulak@ipan.lublin.pl

Atomic Absorption Spectrometry (AAS) is a spectroanalytical procedure for the quantitative determination of chemical elements using the absorption of optical radiation by free atoms in the gaseous state - air mixture with acetylene.

There are 16 trials of fawn soil from July and 16 from November: samples from grass soil at levels 0 - 20 cm and 20-40 cm and samples from fallow soil at the same levels as before. Biochar in these samples was added in different doses.

The results show that there is generally more Ca in samples which were taken in November than in July, grass soil has less Ca than the fallow soil. It is similar in the case of K. There is more Mg in samples than Ca (about 4 or 5 times more).

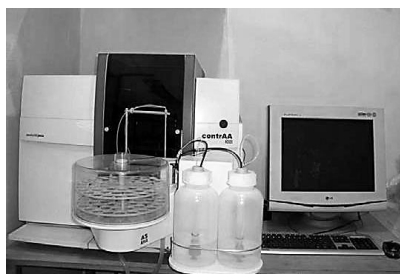

Fig. 1. Analyzer of metals in solutions AAS contr AA 300.

REFERENCES

1. CYGAŃSKI, A. 1997. Spectroscopic methods in analytical chemistry, Warsaw: Scientific and Technical Publishing.
2. www.mcm.ar.krakow.pl/uploads/documents/ASA_2011.doc.

APPLICATION OF TDR TECHNIQUE FOR ESTIMATING EVAPOTRANSPIRATION

*Anna Daniel¹, Grzegorz Janik², Małgorzata Albert², Karol Wolski³,
Paweł Szyszkowski⁴*

¹Distance Learning Center, Wrocław University of Environmental and Life Sciences,
Pl. Grunwaldzki 24a, 50-363 Wrocław, Poland
anna.daniel@up.wroc.pl

²Institute of Environmental Protection and Development,
Wrocław University of Environmental and Life Sciences,
Pl. Grunwaldzki 24, 50-363 Wrocław, Poland
grzegorz.janik@up.wroc.pl; malgorzata.albert@up.wroc.pl

³Department of Agroecosystems and Green Areas Management, Wrocław University of
Environmental and Life Sciences, Pl. Grunwaldzki 24, 50-363 Wrocław, Poland
karol.wolski@up.wroc.pl

⁴Institute of Landscape Architecture, Wrocław University of Environmental and Life Sciences,
Pl. Grunwaldzki 24, 50-363 Wrocław, Poland
pawel.szyszkowski@up.wroc.pl

The paper presents a method for estimating evapotranspiration of selected varieties of lawn grasses. Evapotranspiration was calculated, treating it as the only unknown water balance equation. Water balance was measured by soil moisture sensor (LP/ms) which uses a TDR technique. Measurements were carried out in cylindrical soil columns (each cylinder had a 5 cm in diameter and 15 cm in height).

These analyzes allowed to build maps of evapotranspiration, for which was specified 1-hour time step and coordinates were volumetric water content and temperature at the topsoil. These maps are the base for building automatic control system of air-water relationships in vegetation layer (the topsoil).

REFERENCES

1. JANIK G., 2008. Spatial variability of soil moisture os information on variability of selected physical properties of soil. *Int. Agrophysics* 22, z. 1, s. 26-31.

2. JANIK G., SKIERUCHA W., BŁAŚ M., SOBIK M., ALBERT M., DUBICKI M., ZAWADA A., 2014. TDR technique for estimating the intensity of effective non rainfall. *Int. Agrophysics*, Vol 28, Issue 1, s. 23-37.
3. FEDES R., KOWALIK P., ZARADNY H., 1978. Simulation of field water use and crop yield. PUDOC. Wageningen.
4. BOUSSELOT, J.M., KLETT J.E., KOSKI R.D., 2011. Moisture content of extensive green roof substrate and growth response of 15 temperate plant species during dry down. *HortScience* 46:518–522.
5. DOMENGHINI, J., BREMER D.J., FRY J.D, DAVIS G.L., 2013. Evapotranspiration and performance among turfgrass and ornamental landscape species in response to irrigation deficit. *Intl. Turf. Soc. Res. J.* 405–414.
6. MORARI F., GIARDINI L. 2011. Estimating evapotranspiration in the Padova Botanical Garden. 2011. *IRRIG SCI*, 20(3), 2001, pp. 127-137.
7. BAKHTIARI B., GHAHREMAN N., LIAGHAT A. M., HOOGENBOOM G. 2011. Evaluation of Reference Evapotranspiration Models for a Semiarid Environment Using Lysimeter Measurements. *J. Agr. Sci. Tech.* (2011) Vol. 13: 223-237.

INFLUENCE OF FLOW RATE ON THE EFFICIENCY OF SETS WITH BLADELESS TURBINE

Lukáš Dlabal¹, Martin Polák²

¹Faculty of Engineering, Czech University of Life Sciences Prague
Kamýcká 129, 165 00 Praha, Czech Republic
dlabal@tf.czu.cz

² Faculty of Engineering, Czech University of Life Sciences Prague
Kamýcká 129, 165 00 Praha, Czech Republic
karel@tf.czu.cz

Current hot issues include alternative energy sources. One of them is energy from streams and rivers. The potential of the smallest water sources has not yet been sufficiently exploited and is an opportunity for the bladeless turbine. A water turbine constructed on the water turbulence or whirlpool principle is capable of utilizing very small sources even for untapped water, and it is highly suitable for the closed circuit production of electrical energy. (Beran et al., 2013)

This abstract describes the interaction of two variables - the flow rate and set's efficiency. The measuring has been performed on a SETUR DVE 120 mini-turbine within a closed testing hydraulic circuit in a laboratory of the Department of Mechanical Engineering, Faculty of Engineering, Czech University of Life

Sciences Prague. The circuit design provides for the necessary measuring and modelling of different operating states of the tested turbine. (Polák et al., 2013)

It should be stressed that all the presented turbine parameters are at a constant speed of $n = 200 \text{ min}^{-1}$.

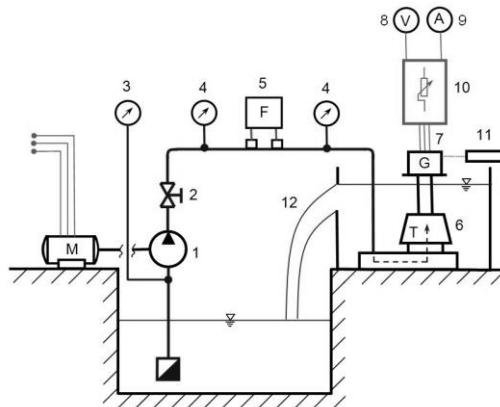

Fig. 1. Diagram of the hydraulic circuit for measuring the DVE 120 mini-turbine characteristics
 1 – pump, 2 – control valve, 3 – vacuum gauge, 4 – pressure gauge, 5 – flow meter, 6 – turbine, 7 – generator, 8 – voltmeter, 9 – ammeter, 10 – resistance load, 11 – speedometer, 12 – overflow discharge. (Polák et al., 2013).

Measuring took place at a defined water gradient, flow rate and load. The following parameters were recorded:

- pressure at the turbine input,
- flow rate in the feeding line,
- turbine speed,
- voltage and current at the generator output

Based on these values, the following has been determined:

- water gradient,
- water flow power at the turbine input,
- generator electric output,
- generating set's overall efficiency

The generating set efficiency is expressed as the ratio of the turbine's electric output power to its hydraulic input power (i.e. the water flow power): (Štoll et al., 1977):

$$\eta = \frac{P_{el}}{P} \quad (1.1)$$

where: P_{el} – electric power [W]
 P – water flow power [W]

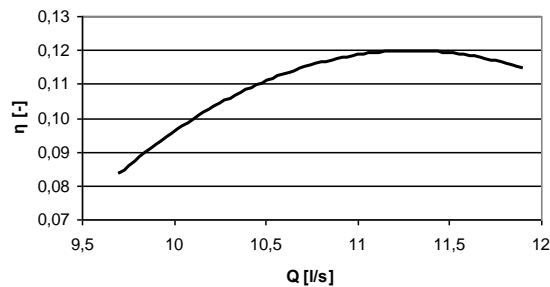

Fig.2. Set's efficiency – flow rate relationship.

Knowledge of the turbine's working characteristics is crucial for its proper operation. This concerns mainly the relationship between the flow rate and the efficiency. The following diagram (Fig. 2) presents the dependency of the set's efficiency on the flow rate. Maximum efficiency is achieved at a certain value of flow rate. Further increasing the flow rate reduces the efficiency. Water flow rates of 9.5 to 12 l/s have been measured during laboratory tests, which correspond to a small mountain creek. The maximum overall set's efficiency reached 12 %.

ACKNOWLEDGEMENTS

This work has been supported by the Internal Grant Agency of the Faculty of Engineering, Czech University of Life Sciences in Prague, Project 2013: 31130/1312/3103 (Determining of operational properties of bladeless turbine).

REFERENCES

1. BERAN V., SEDLÁČEK M., MARŠÍK F., 2013. A new bladeless hydraulic turbine. *Applied Energy*, p. 978-983. ISSN 0306-2619.
2. POLÁK M. et al. 2013. *Bezlopatková miniturbína*, Praha: Nakladatelství ČVUT. ISBN. 978-80-01-05233-4.
3. ŠTOLL Č., KRATOCHVIL S., HOLATA M., 1977. *Využití vodní energie*, Praha: SNTL Praha

MODELING OF SOIL WATER TRANSPORT - NUMERICAL IMPLEMENTATION OF THE RICHARDS EQUATION

Bartłomiej Gackiewicz, Krzysztof Lamorski, Cezary Sławiński

Department of Metrology and Modelling of Agrophysical Processes,
Institute of Agrophysics Polish Academy of Sciences
Doświadczalna 4, 20-290 Lublin, Poland
b.gackiewicz@ipan.lublin.pl

Richards equation which describes the movement of water in unsaturated soil is widely used for calculation of soil water potential and soil moisture. However, direct analytical calculations are not applicable in most cases. Usually numerical approaches are used to solve this equation.

The proposed solution is a numerical implementation of Richards equation using the finite volume method in OpenFOAM – the open source programming environment. The implementation of the Richards equation solver is validated against existing numerical solver and analytical solutions. The validation results indicate the correctness of Richards equation implemented in OpenFOAM. The prepared model, besides the different types of boundary conditions, provides the ability to consider internal sources and sinks which can simulate e.g. the presence of roots in soil. The implementation of Richards equation in OpenFOAM allows of easily taking into account spatial variability of soil hydraulic parameters.

The great benefit of using OpenFOAM solver is the possibility of further modification of the prepared model and taking into account more interactions (e.g. heat and vapor transport).

ACKNOWLEDGEMENTS

The work was partially funded by the National Science Centre (Poland) upon the contract: UMO-2011/01/B/ST10/07544.

**THE MEASUREMENT OF DYNAMIC VISCOSITY
OF BIO LUBRICANTS WITH RHEOMETER ANTON PAAR
MCR 102**

Lubomír Híreš, Ján Csillag, Tomáš Regrut, Ana Petrović, Michal Valach

Department of Physics, Slovak University of Agriculture in Nitra
Tr. A. Hlinku 2, 949 76 Nitra, Slovakia
xhires@is.uniag.sk

Introduction: Viscosity of fats is very important physical property of oils. Viscosity is an extent of internal friction in fluids, so called resistance against mutual movement of molecules of fluid and it is a consequence of action of fluids among molecules. Viscosity is changing with the temperature, it means, with the growing temperature viscosity is falling. This is caused by clustering of molecules in lower temperatures, by decomposition of clusters in rising temperatures and by the increase of free volume in fluids. Viscosity, as one of the most important properties of liquid lubricants, determines: formation of liquid friction or greasing, lubricating film's bearing capacity, size of resistance while starting movable part of engine and sealing ability of lubricants (Stachowiak, Batchelor, 2013).

Dynamic viscosity is defined from Newton's law as a constant of proportion between shearing tension and gradient of fluid's velocity:

$$\tau = \eta \text{ grad } v \quad (1)$$

The unit of dynamic viscosity is Pa.s. Thousand times smaller unit mPa.s is more commonly used (Hlaváč, 2011).

Materials and methods: We used two organic lubricants to measure the dynamic viscosity. The first lubricant which we used was Shell Naturelle HF-E 46. It is a modern hydraulic lubricant which is used in hydraulic and transmission systems. It is easily biologically degradable, it has low ecotoxicity and it is appropriate to be used in ecologically sensitive places (shell-naturalle-hf-e-46, 2013). The second used lubricant was Mogul Hees 46. It is also easily biologically degradable hydraulic liquid lubricant. It is primarily designated for mobile hydraulics, that work in unprotected environment whole the year, mainly if there is a danger of oils spill into the environment in case of system's breakdown (mogul-hees-46, 2013). The measurement of pure oils viscosity is the base for determination of the lubricant's quality. While comparing the properties of selected types of lubricants, we focused on viscosity of bio lubricants. We

measured the dynamic viscosity of organic lubricants with Rheometer Anton Paar MCR 102. We set the temperature into the range from -10 °C to 50 °C. While measuring with Rheometer, the measured sample must meet certain conditions, like e.g.: the temperature of the sample should be constant and homogeneous in whole the volume of sample, the sample must be mixed well and it cannot contain solid particles which have tendency to be deposited. The samples should be without bubbles, which can be removed by vacuum pump. The consistency of the sample must be homogeneous, too. The samples should not be influenced by chemical or physical changes during the measurement. The dependence of dynamic viscosity on temperature is described with Arrhenius' equation

$$\eta = \eta_0 e^{-\frac{E_A}{RT}} \quad (2)$$

where η is dynamic viscosity (Pa.s), η_0 is pre-exponential factor (Pa.s), E_A is molar activation energy of viscous flow ($\text{J}\cdot\text{mol}^{-1}$), R is gas constant ($8,314472 \text{ J}\cdot\text{K}^{-1}\cdot\text{mol}^{-1}$) and T is thermodynamic temperature (K). We can observe that with the growing temperature dynamic viscosity is falling, which affirms validity of Arrhenius' exponential relation (Hlaváč, 2011).

Results: We can see the graphical dependences of dynamic viscosity on temperature in the pictures (Fig. 1 and Fig. 2).

According to Figure 1, the change of the slope appeared in the sample of Shell Naturelle 46 HF-E. This may be caused by water in the sample of the lubricant. When water reached 0 °C, it changed state and this might be caused the change of dependence, which had an impact on the graphical dependence. Graph shows that between temperature and viscosity is strong exponential dependence, what proves also high value of determination's coefficient. The coefficient of determination reached the 0,9734.

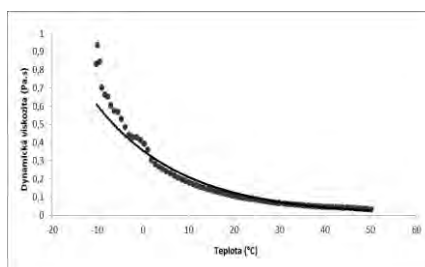

Fig. 1. Dependence of dynamic viscosity on temperature for Shell Naturelle 46 HF-E.

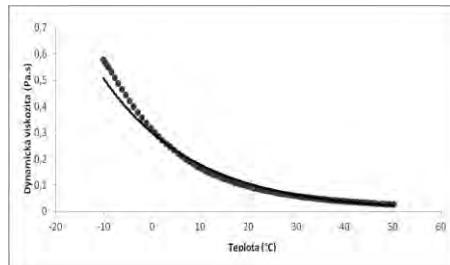

Fig. 2. Dependence of dynamic viscosity on temperature for Mogul Hees 46.

We can see the dependence of dynamic viscosity on temperature for the sample Mogul Hees 46 in the Fig. 2. The change in the slope did not appear in this sample, like did in the sample of Shell Naturelle 46 HF-E. Graph shows that between temperature and viscosity is strong exponential dependence, what proves also high value of determination's coefficient reaching 0,9779.

Conclusion: We measured the viscosity of organic lubricants with Rheometer Anton Paar MCR 102. On the basis of measured graphical dependences we can state that viscosity of given samples falls with rising temperatures. We found out dependences of dynamic viscosity on temperature. We approximated dependences to exponential regressive equation, which affirmed the validity of Arrhenius' exponential relation between viscosity and temperature. Found coefficients of determination R^2 reached high values. As we can see in the mentioned graphical dependences for the samples of lubricants, the curve characterizes the progress well. The change in shape which is showed in the graph might be caused by the considerable quantity of water in the sample, which changed the state with the rising temperature. The measured dependence of dynamic viscosity was acquired with the precision and the obtained dependencies had very high coefficients of determination. Experimentally measured dependences can be used as an input data of technological processes and also as a base for exploring the type of lubricants required for the development of new technologies.

REFERENCES

- HLAVÁČ P., 2011. Reologické vlastnosti potravinářských materiálů : dizertačná práca. Nitra :SPU, 2011. 135 s.
- MOGUL HEES 46 biologicky rozložiteľný hydraulický olej. [on-line], [cit. 2014-04.-09]. Dostupné na internete: <<http://metalpro.kabel1.cz/cz-detail-1085327-mogul-hees-46.html>>.
- SHELL NATURELLE HF-E 46. [on-line], [cit. 2014-03-19]. Dostupné na internete: <<http://www.oilsandstuff.com/products/shell-naturelle-hf-e-46-20-litre>>.
- STACHOWIAK G., BATCHELOR W.A., 2013. Engineering tribology. Oxford : Butterworth-Heinemann, 2013. 1 vyd. 744 s. ISBN 978-0-12-397047-3.

DENSITY ANALYSIS OF SELECTED COMPONENTS OF SORTED MUNICIPAL WASTE

David Houška, Marie Křížová

Czech University of Life Sciences Prague,
Kamycka 129, 16521 Prague 6, Czech Republic
houskad@tf.czu.cz
mkrizova@tf.czu.cz

Introduction: During waste collection is advantageous for collecting companies, but also for the citizens when the content of sorted waste containers is higher level of density. Collecting companies can lower their cost of one ton of waste collection and citizens can more efficiently use the space in their own and the public containers for separate collection. Bulk density can increase by adjusting the waste before throwing it into a container or in storage in the home. For example box from television we should spread before dropping into the container so that does not fill the entire remaining space. Tetra pak or PET bottle we should also press or spread by that there will fit more into the collection container.

Methodics: The most common system of separate collection is a container collection, which is based on the repeated use of collection containers. Frequently used containers for collection are 120, 240 and 1100 l.

The measurement was carried out by using a platform scale with weighting capacity of 500 kg and the smallest increments of 0.01 kg, on which was affixed container with a volume of 120 l filled with waste. Filling the container is done by free pouring of waste into the container without compression or jarring. Recorded masses and a known volume of 120 l containers are processed by using the relationship for the calculation of density. The full level of vessel is determined by replacing the waste by water. In determining various full level of PET bottles was always used the same number of bottles of equal volumes (Table 1).

For the detection of bulk density of the waste can be properly used method when we measure the weight value of content in known volume. For the calculation it is necessary for m install weight of material which is weighed in the container, where it occupies a known volume V .

$$m_V = k \cdot \frac{m}{V}$$

where:

m_V – bulk density [$\text{kg} \cdot \text{m}^{-3}$]

m - weight [kg]

k – conversion factor from liters to m^3

V - volume [l]

Results: Table number one represents the results of the first measurement when the 120 l container was filled with PET bottles in their original form without modification. To the container were added 12 two liters bottle, 24 one and half liters bottle and one half liter PET bottles. Measurements were also performed with the same bottles, after adjustments by pressing and flattening. When we flatten the bottles and put them in to the container, we find that this adjustment shall save space by 43%. When using the press to achieve an even better result we are to save 70% of the space in the container against the insertion of PET without modification.

Table 1. Full level

Full level of plastic waste 120 l container				
Number	PET bottles volume [l]	Without adjustment	Flattening	Press
1	0.5	120 l	68 l	36 l
24	1.5			
12	2			
TOTAL	60.5	100 %	57 %	30 %

The results of second measurements are shown in Table 2. During the measurement we filled the container with a volume of 120 l to the brim. In the second column of the table, we can see how the bottles were adjusted before throwing into the container. The first column is the weight of the contents of the container and the third column shows the calculated bulk density based on the known volume of the container and weighed mass of content. Highest weight value was reached by pressing, which in our case is the maximum (100%). For other methods of treatment is then indicated how many percent of the weight in the container is against the detected peak.

Table 2. Measuring of bulk density

Results of measuring PET bottles – 120 l container			
Weight of plastic waste (kg)	Adjustment	Bulk density (kg m⁻³)	Percent (%)
1.46	without	12.17	28.9
3.16	flattening	26.33	62.6
5.05	press	42.08	100.0

The third measurement was focused on Tetra Pak, which was compared to the volume occupied by the containers without modification before dropping into the container (120 l) and the same number of packages modified (flattened) before dropping into the container. The average number of tetra packs in the vessel was 54 without modifications. After adjusting (flattening) occupy it was only 29.2% of the original volume. For both states was also calculated bulk density (Table 3).

Table 3. Bulk density of TETRA PAK

Bulk density of tetra pak			
Weight (kg)	Adjustment	Bulk density (kg m⁻³)	Full level (%)
1.59	Without	13.25	100.0
1.59	Flattening	45.43	29.2

Conclusion: From the obtained results we can deduce that the most effective adjustment of PET bottles before dropping into the collection container is pressing. During pressing, is the volume of PET bottles scaled to 30%, and achieves a 3.5 greater bulk density than the variations without adjustment. The second adjustment of PET bottles is the most affordable, it does not have bad results also when comparing with the variant without modification. At Tetra Pak was found that by modifying the tetra pak before dropping into container we can save 70.8% of the space. The results confirm that the modification of the above commodities at home or right before dropping into the container can have a positive economic effect for the collection and distribution company and a higher rate of utilization of the collection containers in the home or in public.

ACKNOWLEDGEMENTS

The paper was written with the financial support of task 2014:31180 / 1312/3132 Analysis of selected physical properties of sorted municipal waste.

REFERENCES

1. PLÍVA a kol.: 2009. Kompostování na volné ploše v pásových hromadách Profi Press, s.r.o., ISBN 978-80-86726-32-8 1. vydání, 136 s.
2. VÁŇA J.: 2004. Pevné odpady. Česká zemědělská univerzita v Praze, ISBN 80-213-1273-4, 178 s.

MODELING OF SEWAGE PURIFICATION IN SBR REACTORS USING A DEDICATED SIMULATOR

Katarzyna Jaromin-Gleń

Department of Natural Environment Biogeochemistry
Institute of Agrophysics Polish Academy of Sciences
Doświadczalna 4, 20-290 Lublin, Poland
k.jaromin-glen@ipan.lublin.pl

Nowadays, the Wastewater Treatment Plants (WWTP) have had to adapt the volume of the chamber because of the tendency to increase concentrations of pollutions and simultaneously decrease wastewater flow streams. To solve these problems, computer programs based on mathematical models prove very helpful. They enable making the simulation of various proposed solutions. The use of computer programs for modeling WWTP objects is currently an important tool, but in future it will be an indispensable tool for exploiters' activity (Dymaczewski et al., 2002). Computer programs can be divided into two types: the dedicated ones (e.g.: GPS-X, SIMBA, WEST) and of general use (MATLAB/Simulnik) (Montusiewicz et al., 2010). Using computer programs the exploiter can do any types of objects, e.g.: an industrial or a laboratory scale.

Therefore to carry simulation studies into the schedules of the work of a laboratory SBR (Sequencing Batch Reactor), a simulation model of this reactor was made using the GPS-X, the program of a company Hydromantis Environmental. The scheme of the modeled system is shown in Fig. 1.

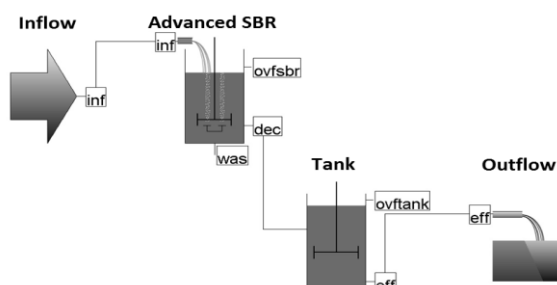

Fig. 1. Scheme of the modelled.

The data for the simulation were based on the project of SBR and the results of measurements on the SBR reactor. Using the model, optimum parameters of the wastewater process were established as well as the satisfactory value of the efficiency of wastewater pollutants removal were obtained (Jaromin-Gleń et al. 2013). A satisfactory efficiency level of treatment in the modeled system was obtained for total nitrogen, COD, BOD₅ and total suspended solids. In turn, the efficiency of total phosphorus was lower than the obtained one during the measurements in the reactor SBR on a laboratory scale.

ACKNOWLEDGEMENTS

Research project financed from the budget for science in the years 2012-2013 within the “Diamond Grant” program. Grant no. 0013/DIA/2012/41.

REFERENCES

1. DYMACZEWSKI Z., OLESZKIEWICZ J. A., LOZAŃSKI M., 1998. Poradnik eksploatatora oczyszczalni ścieków, Poznań, Polskie Zrzeszenie Inżynierów i Techników Sanitarnych.
2. MONTUSIEWICZ A., ŁAGÓD G., PIOTROWICZ, A., 2010. Modelowanie systemów oczyszczania ścieków. Lublin: Monografie Komitetu Inżynierii Środowiska PAN vol. 74.
3. JAROMIN-GLEŃ K. M., ŁAGÓD G., 2013. Sprawność usuwania wybranych zanieczyszczeń ze ścieków miejskich w laboratoryjnym bioreaktorze typu SBR. Proceedings of ECOpole, 7(1), p. 357-363.

THEORETICAL AND EXPERIMENTAL ANALYSIS OF LINEAR AND NON-LINEAR COMPRESSION OF OILSEED CROPS

Abraham Kabutey, David Herak, Riswanti Sigalingging

Department of Mechanical Engineering, Faculty of Engineering;
Czech University of Life Sciences Prague
Kamycka 129, 165 21, Suchdol - Prague 6, Czech Republic
kabutey@tf.czu.cz
herak@tf.czu.cz
sigalingging@tf.czu.cz

The knowledge of linear and non-linear compression of oilseed crops such as *Jatropha*, Sunflower, Rape and others are imperative for the design and development of efficient technology for oil expression. In recent times, the oil from oilseed crops has gained considerable awareness as a potential energy resource to supplement the continuing reduction of fossil fuels as a result of the increasing population with growing demand. This urgent need stems from the common literature statement by Rudolf Diesel who tested his engine on peanut oil at 1900 World's Fair in Paris, the Exposition Universalle (Nitske and Wilson, 1965). In linear pressing whereby a Universal Testing Machine is used for the axial compression of bulk oilseed under required compression speed and compressive force, a theoretical or mathematical model including the Tangent Curve Function, Reciprocal Slope Transformation and Finite Element Method have been developed to illustrate the compression behaviour in terms of the dependency between compressive force and deformation characteristic curve as well as the mechanical properties such as deformation, force and energy (Herak et al., 2013a; 2014; Petru et al., 2013). The results of these published models provide useful information in understanding the exact compressive force and energy requirement for obtaining maximum oil from a particular oilseed crop under compression loading. Specifically, tangent curve and reciprocal slope transformation mathematical models were based on the description of bulk *Jatropha* oilseed whiles that of FEM was related to a single oilseed. Experimentally, the non-linear pressing involving a screw press type FL 200, Farmet Model has been also examined for *Jatropha curcas* bulk seed where the oil yield and temperature were respectively determined at the screw press chamber positions (Kabutey et al., 2011). The published result of this study was further analyzed theoretically in terms of pressure requirement along the screw chamber positions using tangent curve mathematical model (Herak et al., 2013; Kabutey, 2014). It is important to highlight here that the tangent curve model was

mainly analyzed for *Jatropha curcas* bulk seed of moisture content 8.5% (d.b.). From the theoretical analysis of pressure, it was observed that pressure increased linearly along the screw chamber positions and the increment did not necessarily increase the percentage oil yield as hypothetically stated in the literature that increase in pressure thus increases oil yield (Karaj and Muller, 2011). To gain better understanding of the linear compression process, one of the necessary studies is currently underway to examine the relaxation process of the bulk oilseed crops particularly *Jatropha curcas* as a preliminary study for other oilseed crops and this idea would be applied in the non-linear pressing for the optimization of the oil recovery efficiency and energy requirement. In addition, FEM simulation model would be employed for the description of a defined bulk oilseed thus each single seed from a measured volume of seed should be simulated individually to understand the actual pressing process in linear compression.

ACKNOWLEDEMENT

The continuing research is being supported by the Internal Grant Agency of Faculty of Engineering, CULS Prague, IGA – 31130/1312/3102.

REFERENCES

1. NITSKE W.R., WILSON C.M. 1965. Rudolf Diesel Pioneer of the Age of Power, University of Oklahoma Press, Norman, OK.
2. HERAK D., KABUTEY A., DIVISOVA M., SIMANJUNTAK S. 2013a. Mathematical model of mechanical behaviour of *Jatropha curcas* L. seeds under compression loading. *Biosystems Engineering*, 114 (3), 279–278.
3. HERAK D., BLAHOVEC J., KABUTEY A. 2014. Analysis of the axial pressing of bulk *Jatropha curcas* L. seeds using reciprocal slope transformation, *Biosystems Engineering*, 121: 67–76.
4. KABUTEY A., HERAK D., HANUS J. 2010. Screw press performance for oil extraction from *Jatropha curcas* L. seeds of different moisture content. *Scientia Agriculturae Bohemica*, 41(4):225-230.
5. KABUTEY A. 2014. Optimizing the use of screw presses for processing oilseed crops. PhD Dissertation, Faculty of Engineering, Department of Mechanical Engineering, Czech University of Life Sciences Prague.
6. KARAJ S., MULLER J. 2011. Optimizing mechanical oil extraction of *Jatropha curcas* L. seeds with respect to press capacity, oil recovery and energy efficiency. *Industrial Crops and Products*, 34: 1010–1016.
7. PETRU M., NOVAK O., HERAK D., SIMANJUNTAK S. – 2012. Finite element method model of the mechanical behaviour of *Jatropha curcas* L. seed under compression loading. *Biosystems Engineering*, 111 (4), 412–421.

MODIFICATION OF ZEOLITE SURFACE CHARGE FOR WASTEWATER TREATMENT

*Karolina Kędziora, Justyna Piasek, Justyna Szerement,
Anna Ambrożewicz-Nita, Jolanta Cieśla, Grzegorz Józefaciuk*

Department of Physicochemistry of Agricultural Materials
Institute of Agrophysics Polish Academy of Sciences
Doświadczalna str 4, 20-290 Lublin, Poland
kkedziora@iapan.lublin.pl

Nitrogen and phosphorus compounds from agriculture or municipal and industrial wastewaters are one of the major hazardous pollutants of the aquatic environments. Presence of these ions increases eutrophication of water races and reservoirs, as well as reduces effectiveness of some water treatment processes such as chlorination or filtration.

Nitrogen and phosphorus removal from wastewater based on physicochemical and biological processes gives frequently not satisfactory results. Anion exchanging sorbents are rarely used for nitrates and phosphates removal due to their high price. Application of natural sorbents is useless because they are mostly cation exchangers⁵. Natural zeolites have extremely high negatively charged surface areas, which enables their use as relatively no expensive sorbents of many various contaminants. However, their possible use as nitrates or phosphates sorbents requests recharging their surface from negative to positive.

In the present studies we tried to recharge the surface of a zeolitic tuff by iron polycations and hydroxides sorption. Natural clinoptilolite from Socirnica mine (Ukraine) and its sodium homoionic form were used for this purpose (Fig. 1). The sodium form of zeolite was obtained by triple equilibration of a natural zeolite with 0.5 M NaCl, washing with distilled water and air-drying. Sodium zeolite was next treated by 24h with 0.1 M FeCl₃, adjusted to different pH values ranging from 3 to 10, and separated by centrifuging. Zeta potential distribution was determined for the resulting materials suspended in water. Only zeolite treated at pH 3 had a positive zeta potential value (Tab. 1). This suggests that it could be used as a sorbent for nitrates and phosphates from wastewaters at low pH values. However, the negative mean values of zeta potential do not exclude the existence of positively charged areas on zeolites modified at other pH's. It was confirmed by high dispersion of zeta potential distributions which were partly located at positive values of zeta potential. These reflects the heterogeneity of analyzed

samples in terms of the surface electric charge. Positively charged parts of zeolite surface will be occupied by anions during adsorption from wastewater. This will be more precisely studied in the next step of our investigations.



Fig. 1. Picture of zeolite samples during preparation of sodium form.

Table 1. Values of electrokinetic potential of zeolite modified at different pH:

pH	Zeta potential (mV)
3	6.2 ± 1.8
4	-7.8 ± 1.1
5	-20.2 ± 1.9
6	-30.5 ± 2.0
7	-44.7 ± 1.6
8	-46.3 ± 1.9
9	-49.1 ± 1.0
10	-49.6 ± 1.5

The effectiveness of the zeolite modification at pH 3 is also reflected by the colour of the material, which, among other materials, changed most intensively from green to red. This demonstrates the presence of Fe^{3+} ions on the surface of the mineral.

The studies should be extended to carry out further modifications of zeolite surface to obtain materials exhibiting point of zero charge at neutral or alkaline pH's, which allow to sorb anions from wastewater at high pH values.

ACKNOWLEDGEMENTS

This research was financed by the Project No IPBU.01.01.00-06-570/11-00 Developing an innovative model of the cross-border use of zeolitic tuff.

REFERENCES

1. LEVINE S.N., SCHINDLER D.W., 1989. Phosphorus, Nitrogen, and Carbon Dynamics of Experimental Lake 303 during Recovery from Eutrophication. Canadian Journal of Fisheries and Aquatic Sciences, 46, p. 2-10.
2. Li J.F., Li Y.M., MENG Q.L., 2010. Removal of nitrate by zero-valent iron and pillared bentonite. J. Hazard. Mater, 174, p. 188-193.
3. PARK J.B.K., CRAGGS R.J., SUKIAS J.P.S., 2009. Removal of nitrate and phosphorus from hydroponic wastewater using a hybrid denitrification filter (HDF). Bioresource Technology, 100, p. 3175–3179.
4. ŚWIDERSKA-DĄBROWSKA R., SCHMIDT R., SIKORA A., 2011. Właściwości fizykochemiczne zeolitu modyfikowanego jonami żelaza. Inżynieria Ekologiczna , 24, p. 195-204. – Influence of the calcination temperature of iron modified zeolite on its chemical stability (pol.)
5. WANG S., PENG Y., 2010. Natural zeolites as effective adsorbents in water and wastewater treatment. Chemical Engineering Journal, 156, p. 11-24.

**INFLUENCE OF SOLAR RADIATION ON HEAT TRANSFER
PROCESS IN SOLAR COLLECTORS**

Ivett Kocsány, Istvan Seres

*Department of Physics and Process Control,
Szent István University
Páter K. u. 1., Gödöllő, H-2103 Hungary
Kocsany.Ivett@gmail.com*

In solar collectors the heat is extracted by the heat transfer fluid, which flowing through the tubes. In this paper the heat flow from the absorber to fluid through the tube wall has been analyzed. Usually the conductance of the absorber and tube wall material has good thermal conductivity, but it has to be taken to account in an appropriate model. Accordingly it has to be taken into account that how the optical attribution of the materials influenced the efficiency of a flat plate collector. The amount of the absorbed solar radiation by the absorber plate has been determined, included multiple reflection, cover transmittance and absorptance of the absorber plate. Developed models were carried out for specially vacuum tube and flat plate solar collectors. Based on simulated results the conclusions have been performed.

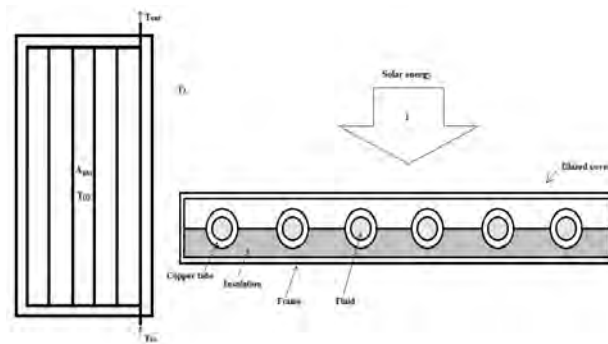

Fig. 1. Structure of the flat plate solar collector.

The role of convection and conduction heat transfer in the performance of solar systems is obvious. Radiation heat transfer plays an important role in bringing energy to earth, but it is not so manifest that radiation heat transfer plays a significant role in the operation of solar collectors. To calculate the heat loss can be very complicated, because of the variant components. Usually in practice radiation heat transfer is often negligible (Duffie & Beckman, 1991). In a thermal collector flux of the solar energy is large-scale smaller than in conventional heat transfer equipment. In addition to required preciseness, one must be taken to account available accuracy.

Emissivity of the absorber plate is specially characterized by the selective coatings where emissivity may have fluctuating between 10-50% (Spuckler & Siegel, 1992). This value is depending on the type and manufacture of the coating. It is difficult to anticipate the convective heat transfer with better than 20% accuracy. In solar collectors the heat is extracted by the heat transfer fluid, which flowing through the tubes (Shah & Furbo, 2007). In this paper the heat flow from the absorber to fluid through the tube wall is analyzed. Usually the conductance of the absorber and tube wall material has good thermal conductivity, but it has to be taken to the account in a correct model. The heat flow from wall to fluid occurs by convection and is described by the convective coefficient. Even though the achievable overall accuracy of a heat loss calculation may be quite low, there are situations where one would like to model certain details with much greater precision.

In this paper a more accurate calculation was taken into account all the multiple reflections. A numerical model is developed to simulate how the absorbed solar energy is converted to heat energy of the solar liquid. Our model is based on the heat transfer from copper tubes to copper absorber plate Fig. 1. Even though the achievable overall accuracy of a heat loss calculation may be quite low, there are situations where one would like to model certain details with much

greater preciseness. Finally the solar radiation is be absorbed by the absorber. Because of the absorber plate is not perfectly black, multiple reflections between cover system and absorber plate has to be considered. The multiple reflections seem as a geometric series for the fragment of the incident solar radiation. Based on the measured data, the rate of reflected radiation is principally depends on the angle of incident radiation. Solar radiation includes both beam and diffuse components. In general, the magnitude of the reflected intensity a particular direction for a given surface is a function of the wavelength and the spatial distribution of the incident radiation.

ACKNOWLEDGEMENT

The research was carried out with the support of the OTKA K84150 project.

REFERENCES

1. DUFFIE JA, BECKMAN WA., 1991. Solar engineering of Thermal Processes. Second edition. John Wiley and Sons Inc., New York.
2. JIVAN S. L., FURBO S., 2007. Theoretical flow investigations of an all glass evacuated tubular collector. *Solar Energy* 81, 822–828.
3. SPUCKLER C.M., SIEGEL R. 1992. Refractive index effects on radiation behaviour of heated absorbing-emitting layer, *J. Thermophys. Heat Transfer* 6 (4),pp. 596–604.

THE EFFECT OF PREPARATION CONDITIONS ON THE SEDIMENTATION OF CLAY SUSPENSION

Magdalena Koczańska, Jolanta Cieśla, Andrzej Bieganowski

Department of Natural Environment Biogeochemistry
Institute of Agrophysics Polish Academy of Sciences
Doświadczalna 4, 20-290 Lublin, Poland
m.koczanska@ipan.lublin.pl

In our research we examined the influence of preparation conditions on the sedimentation time of clay suspensions.

Clay fractions have the size of below 0.002 mm, so they are the smallest particles of soil. Loess, dusty and sandy soils have different concentrations of the clay fraction. The aim of this study was to show the differences in sedimentation of their clay fractions in the same solution, but with varied methods of sample preparation (e.g. with or without elimination of organic matter). Dynamic light scattering (DLS) experiments were conducted to determine the aggregation

behaviour and to estimate the particle size of the different clay suspensions. These measurements were performed using Zetasizer Nano ZS (Malvern Instruments).

Aggregation profiles of the different clay suspensions confirmed the improved stability of the clay particles in the absence of organic matter. This can be useful for the study of soil sedimentation and preparation of the samples.

REFERENCES

1. BIEGANOWSKIA., WITKOWSKA-WALCZAK B., GLIŃSKI J., SOKOŁOWSKA Z., SŁAWIŃSKI C., BRZEZIŃSKA M., WŁODARCZYK T. 2013. Database of Polish arable mineral soils: a review. *International Agrophysics*, 27, p. 335-350.

PLANT RESPONSE TO DROUGHT STRESS

Katarzyna Kondracka, Artur Nosalewicz, Jerzy Lipiec

Department of Soil and Plant System,
Institute of Agrophysics Polish Academy of Sciences in Lublin
Doświadczalna 4, 20-290, Poland
k.kondracka@ipan.lublin.pl

Drought is one of the major environmental factors that negatively impacts agricultural yield throughout the world. To cope with stresses plants respond with many physiological and biochemical changes. Drought induced, reduced transpiration and resultant higher temperatures in plant foliage sometimes exceed the optimum temperature for efficient photosynthesis.

Water deficit induces chain of physiological changes in plants. However response to drought depends on the plant species, stage of development as well as intensity and duration of stress. Predisposition of plants to maintain high water potential in the tissues during drought is called drought stress resistance. Plant's tolerance to water deficit depends on ability to maintain physiological and biochemical functions at low water potential. One of the ways to maintain water potential in plant tissues at drought is to uptake water from deeper soil (Sangtarash *et al.*, 2009; Leach *et al.*, 2011; Rahman and Hasegawa, 2011). Plant usually use large part of assimilates to develop deeper roots at drought, at the same time increased factor of root to shoot mass, reduction of leaf number and leaf area is observed. As a consequence a reduction in plant biomass and decrease in the intensity of photosynthesis occurs (Maes *et al.*, 2009; Sangtarash *et al.*, 2009; Leach *et al.*, 2011).

The fast changes of concentration of some plant hormones, for example: abscisic acid (ABA) is a plant response to dehydration. High concentration of abscisic acid leads to stomatal closure that reduces transpiration and consequently water loss. Another sign of drought stress in plant tissues is accumulation of proline involved in cell osmotic adjustment and protection of cell components during dehydration. The concentration of proline can be up to 100 times higher in stressed than no stressed plants. Use of the cultivars with higher proline and ABA content under drought stress is a practical approach to select drought tolerant plants (Bellinger Y. and Larher F. 1987; Seyed Y. et al. 2012).

ACKNOWLEDGEMENTS

The results were obtained within an international research project named: “FACCE MACSUR Modelling European Agriculture with Climate Change for Food Security”. We gratefully acknowledge financial support from the National Centre for Research and Development in Poland.

REFERENCES

1. BELLINGER Y., LARHER F. 1987. Proline accumulation in higher plants: A redox buffer? *Plant Physiol. (Life Sci Adv.)*, 6,23-27.
2. ISMAIL Md., MOFIZUR R., HIROSHI H. 2011. *Water stress*. Intech Europe, Rijeka, Croatia.
3. LEACH K.A., HEJLEK L.G., HEARNE L.B., NGUYEN H.T., SHARP R.E., DAVIS G.L., 2011. Primary root elongation rate and abscisic acid levels of maize in response to water stress. *Crop Science* 51(1)157-172.
4. MAES W.H., ACHTEN W.M.J., REUBENS B., RAES D., SAMSON R., MUYS B., 2009. Plant-water relationships and growth strategies of *Jatropha curcas* L. seedlings under different levels of drought stress. *Journal of Arid Environments* 73(10)877-884.
5. SANGTARASH MH, QADERI MM, CHINNAPPA CC, REID DM., 2009. Differential sensitivity of canola (*Brassica napus*) seedlings to ultraviolet-B radiation, water stress and abscisic acid. *Environmental and Experimental Botany* 66(2) 212-219.
6. SEYED Y., LISAR S., ROUHOLLAH M., MOSHARRAF M. Hossain and Ismail M. Rahman M., 2012. *Water Stress in Plants: Causes, Effects and Responses*, Water Stress (Ed. Ismail Md. Mofizur Rahman), Intech Europe, Rijeka, Croatia.

MICROBIOLOGICAL AND BIOCHEMICAL PROPERTIES OF SLUDGE FROM FRUIT WASTEWATER TREATMENT PLANT AND ITS IMPACT ON SOIL ENVIRONMENT

Anna Kot, Magdalena Frąc, Jerzy Lipiec

Department of Soil and Plant System,
Institute of Agrophysics Polish Academy of Sciences
Doświadczalna 4, 20-290 Lublin, Poland
a.kot@ipan.lublin.pl

Agricultural application of sewage sludge could provide a beneficial way to dispose of the increasing amounts of sludge generated in modern world. The major profit of sludge utilization is supply arable land with basic plant nutrients (N and P) and some of the micronutrients (e.g. Cu, Zn, Mo, and Mn). Moreover, it improves the soil physical properties as soil water capacity and soil structure. However, potential benefits may be limited by health hazards like presence of pathogenic organisms, contamination by highly toxic substances and heavy metals. The greater danger is accumulation and transmission of hazardous components to soil, crops, grazing animals, humans and groundwater (Korentajer, 1991).

Introduction the sludge to the soil may cause a numerous perturbations in soil function. Therefore, the sewage sludge should be thoroughly examined before application to soil. The aim of the study was to establish whether the sludge from fruit wastewater treatment plant is safe and could be agriculturally disposed. Also we try to predict potential benefits or risks for the soil environment based on results from CLPP- Community Level Physiological Profiling method (Garland and Mills, 1991) and microbial properties of sludge. CLPP method provide information about environmental samples like microbial functional diversity as Shannon-Weaver index (H) or ability of microorganisms to use range of carbon sources as Substrate Richness (S).

The sludge complies with regulations in polish law (Regulation of the Minister of Environment). There was the lack of pathogenic bacteria of the *Salmonella* genus in 100 g of sludge dry mass and the lack of parasites eggs (*Ascaris sp*, *Trichuris*, *Toxocara sp*). Also concentration of Pb, Cd, Cr, Cu, Ni, Zn, Hg was safe for humans and animals health. The pH was 8.5, the percentage of organic matter was 50.9. There were 30×10^3 cfu of fungi cultured on Martin medium and 69×10^5 cfu of bacteria cultured on medium with soil extract. The microbial activity of sludge measured as dehydrogenases activity was $Adh = 38.74 \pm 1.95$ mg TPF $kg^{-1} d^{-1}$.

Results showed that sludge is abundant and safe source of organic matter. One of the advantages of this sludge is high pH level which ensure protection against soil acidification. High values of Adh, H and S indicate that microorganism when transfer to soil may maintain high biological activity and they may easily adapt to new conditions. The level of utilization of the individual carbon sources indicates that with the sludge, soil will be enriched with numerous microorganisms capable of utilize the underground and aboveground plant material and substrates directly derived from the fruit.

REFERENCES

1. GARLAND J.L., MILLS A.L., 1991. Classification and characterization of heterotrophic microbial communities on the basis of patterns of community-level sole-carbon-source utilization. *Applied and Environmental Microbiology* 57/8 p.2351-2359.
2. KORENTAJER L., 1991. Review of the agricultural use of sewage sludge. Benefits and potential hazards. *Water SA*, 17/3, p. 189-196.
3. Regulation of the Minister of Environment on municipal sewage sludge on 13 July 2010 (in Polish).

APPLICATION OF BIOLOG FF MICROPLATE™ FOR METABOLIC PROFILING OF FUNGI FROM THE GENUS *FUSARIUM*

Natalia Kotowicz, Magdalena Frąc, Jerzy Lipiec

Department of Soil and Plant System,
Institute of Agrophysics Polish Academy of Sciences
Doświadczalna 4, 20-290 Lublin, Poland
n.kotowicz@ipan.lublin.pl

Filamentous fungi of to the genus *Fusarium* occur in natural conditions in different regions all over the world. Most of them are saprophytes, but some species can be a cause of serious plant diseases. In recent years the occurrence of phytopathogenic fungi belonging to the genus *Fusarium* in cereal crops has been increasing (Champeil *et al.*, 2004). Their harmful effect is manifested by decrease of the quantity and deterioration in quality of yield and involves mycotoxins production that may cause inhibition of seeds germination, necrosis and other symptoms. Moreover, mycotoxins are dangerous for animals and human and their presence in food products poses threat to health (Summerell *et al.*, 2003).

In recent years, environmental monitoring has focused on fungal isolates as the source of serious problems requiring constant attention from phytopathologists. Filamentous fungi such as *Fusarium* are known to have unique biochemical pathways. They have ability to assimilate a vast array of simple and complex nutrients available to them and to produce a variety of metabolites. Morphological and biochemical uniqueness of these microorganisms are commonly used for their identification (Singh, 2009). The Biolog FF MicroPlate™ is the first comprehensive and rapid identification and characterization system designed for filamentous fungi and yeast, including species from over 15 genera. This product based on differential abilities of fungi to utilize 95 discrete carbon sources. The FF MicroPlate employs a redox chemistry based on reduction of tetrazolium, responds to the process of metabolism (oxidation of substrates). The Biolog FF database also analyzes fungal growth via turbidimetric analysis.

The aim of conducted experiment was to evaluate the metabolic capability of environmental isolates of fungi belonging to the genus *Fusarium* obtained from winter wheat plants.

REFERENCES

1. CHAMPEIL A., DORÉ T.,FOURBET J. F. 2004. *Fusarium* head blight: epidemiological origin of the effects of cultural practices on head blight attacks and the production of mycotoxins by *Fusarium* in wheat grains. *Plant science*, 166, p. 1389-1415.
2. SINGH M. P. 2009. Application of Biolog FF MicroPlate for substrate utilization and metabolite profiling of closely related fungi. *Journal of Microbiological Methods*, 77, p. 102–108.
3. SUMMERELL B. A., SALLEH B., LESLIE, J. F. 2003. A utilitarian approach to *Fusarium* identification. *Plant disease*, 87, p. 117-128.

THE STUDY OF YOUNG'S MODULUS OF FRUITS DURING DEVELOPMENT USING ATOMIC FORCE MICROSCOPY

*Arkadiusz Kozioł¹, Justyna Cybulska¹, Beata Kruk¹, Dorota Sysa¹,
Małgorzata Lekka², Artur Zdunek¹*

¹Department of Microstructure and Mechanics of Biomaterials
Institute of Agrophysics Polish Academy of Sciences
Doświadczalna 4, 20-290 Lublin, Poland
a.kozioł@ipan.lublin.pl

²Institute of Nuclear Physics, Polish Academy of Sciences,
Radzikowskiego 152, 31-342 Kraków, Poland,
malgorzata.lekka@ifj.edu.pl

The mechanical properties of the cell wall of a plant are very important for its functioning. The cell wall maintains a correct shape of protoplast, strength and protection from the outside. The biological and physical processes which occur in a cell wall during plant growth and ripening are reflected in the properties of texture of fruits and vegetables, which determine a consumer's quality and macroscopic properties.

This study presents atomic force microscopy (AFM) method for testing Young's moduli of cell wall material (CWM) extracted from pears. Cell wall fragments were isolated from pears (*Pyrus communis* L.) of two cultivars: 'Conference' and 'Xenia', by using alcohol insoluble residue (AIR) method. In the experiment fruits at various stages of development were used, at the pre-harvest, harvest and after-harvest periods. In the post-harvest period pears were stored in a cold room with ambient temperature of 2°C. In addition, fruits were stored in shelf-life conditions for ca. 7 days.

CWM fragments, containing natural assemblies of cellulose, hemicellulose and pectins, were absorbed on glass substrate. The AFM elasticity measurements (up to ca. 58 nN of load force) were carried in ultrapure water within an area of 100 μm² in a regular matrix of 8 × 8 points. The Young's modulus was calculated using the Sneddon model. The Poisson's ratio was assumed as 0.3. To reveal the differences among the samples the indentation of 100 nm was chosen.

There has been observed a significant change of Young's modulus during the growth of fruits, for 'Conference' from 2 MPa to 0.5 MPa and from 3 MPa to 1 MPa for 'Xenia' (Fig. 1). The AFM studies of CWM at nanoscale reflect the differences between cultivars and the kinetics of fruits' development. In the post-harvest terms, the Young's modulus was set on the certain level and even

increased, which may suggest, that an important role during this period in the macroscopic properties plays a middle lamella (degradation), not the polysaccharides degradation in primary cell wall.

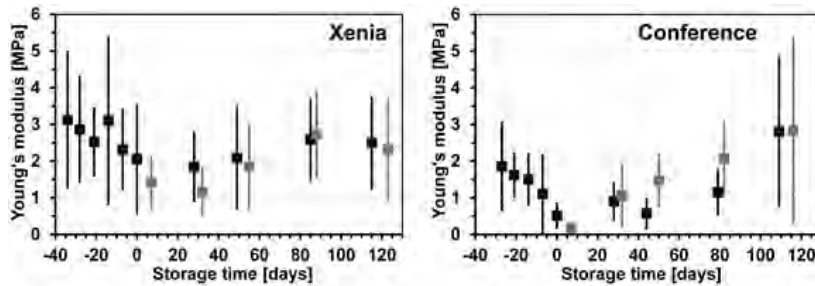

Fig. 1. Mean of the Young's modulus (indentation of 100 nm) of CWM from two pear cultivars during fruit development. Grey squares represent samples of shelf-life conditions. Day zero is the harvest day. Preharvest terms are given for <0 and postharvest for >0.

ACKNOWLEDGEMENTS

The study was supported by the National Science Centre, Poland, DEC 2011/01/B/NZ9/00787.

APPLICATION OF INDUSTRY SENSORS FOR MEASURING OF THE SOIL ROUGHNESS BEFORE TILLAGE

Milan Kříž

Department of Electrical Engineering and Automation,
Czech University of Life Sciences Prague
Kamýčká 129, 165 21 Praha 6 – Suchbátka, Czech Republic
krizm@tf.czu.cz

In these days, needs of intelligent control in precision agriculture arises. The survey of the soil surface roughness during the crossing of the agriculture machine specifically. To detect the soil surface roughness simple mechanical methods has been used. These methods, however, cannot be used for the needs of modern agriculture. Since in industry commonly uses a various types of industrial sensors, arises the question of the use of these sensors in agriculture.

This contribution deals with usage of three types of industrial sensors for distance measurement (Infrared, Ultrasonic and Laser) for soil surface roughness measurement of the testing area of the field. This area represents agriculture land before tillage. Testing area of the field is 1000 mm long and contains three testing points for which height is known. More details about these sensors (Fig.1.) are in Table 1.

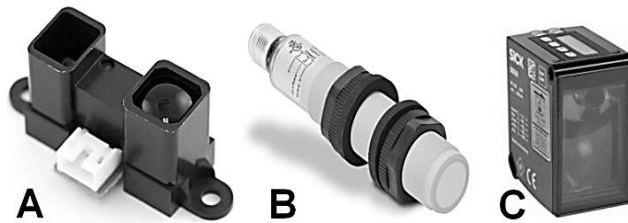

Fig. 1. Sensors **A** – Infrared SHARP, **B** – Ultrasonic M18 UK-1, **C** – Laser SICK.

Table 1. Sensors parameters

	SHARP GP2Y0A02YK	M18 UK-1	SICK DT50
Voltage analogue output	0,4 – 2,8 V	0 - 10 V	0 - 10 V
Resolution	± 10 mm	1 mm	1 mm
Operating voltage	7 V	15 - 30 V	15 – 30 V
(Repeat) Accuracy	10 %	0,5 %	± 10 mm

By means of electric industry linear motion, measurement setup for agriculture machine simulation has been created (Fig. 2.). Every sensor was attached to the head of the linear motion. All sensors have analog voltage outputs.

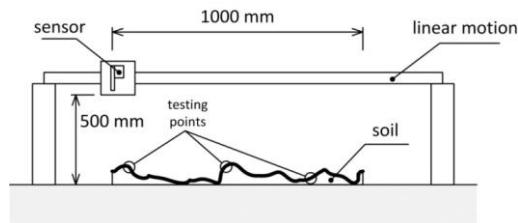

Fig. 2. Measurement setup.

Data from sensors were digitized by data acquisition card NI 6008 (Fig. 3). Subsequently all measured data will be processed by LabVIEW software with sampling frequency of 1 kHz. From measurement data profilograms will be created.

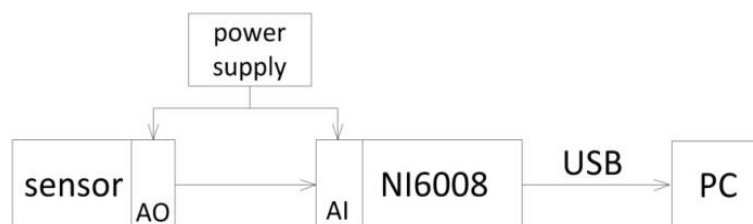

Fig. 3. Block diagram of the measurement chain.

As a result comparison of all three sensors by means of profilograms will be presented. From three testing points the true resolution of sensors will be also determined.

ACKNOWLEDGEMENTS

This research was supported by the grant no. 2013: 31200/1312/3124 “Soil Relief Scanning Sensors Design” by the Internal Grant Agency of the Czech University of Life Sciences Prague.

REFERENCES

1. HAUBROCK S.N. – ET AL., 2009. Spatiotemporal variations of soil surface roughness from in-situ laser scanning. *Catena*, 79, p. 128-139.
2. JESTER W., KLIK A., 2005. Soil surface roughness measurement—methods, applicability, and surface representation. *Catena*, 64, p. 174-192.
3. KRÍŽ M., LINDA M., PAPEŽOVÁ S., 2013. Application of the proximity sensors for measuring of soil surface roughness. *MAGNANIMITAS. Vol. IV. 2013*.
4. DOSTÁL T., AXMAN V., 2007. *Elektrické filtry*. Elektronické skriptum FEKT VUT v Brně.
5. SICK. 2009. Laser distance sensor DT50 Laser class 1. *Data sheet*
6. SHARP GP2Y0A02YK Long Distance Measuring Sensor. *Installation manual*. Best. Nr. 185364.
7. UK1C M18. 2012. Cylindrical Ultrasonic Sensor. Micro Detectors-Italian Sensors Technology. *Installation manual*.
8. ĎAĎO S., KREIDL M., 1996. *Senzory a měřicí obvody*. dtto, Praha.
9. RIEGLER T., ET AL., 2013. Characterizing quality of work for tillage by image data processing. *LAND. TECHNIK – AgEng 2013*, p.315–326.

HOUSEHOLD WASTES AS A SUBSTRATE FOR BIOGAS PRODUCTION

Jan Kuna, Andrzej Bieganowski

Department of Natural Environment Biogeochemistry,
Institute of Agrophysics Polish Academy of Sciences
Doświadczalna 4, 20-290 Lublin, Poland
j.kuna@ipan.lublin.pl

Residual wastes are materials that are disposed from households. Due to data shown in many publications there is a real methanogenic potential in this kind of material. It specially regards to organic wastes. About 35% of garbage content are biowastes, this amount gains range between 50-100 kg per Europe inhabitat (Dublein et al. 2006). Taking into account many environmental reports there is dangerous of destabilization of agriculture production. The reason are energy crops, which cultivation could take a majority of agriculture lands. This situation could affect increase food prices. From the other hand there is also dangerous for landscapes. Monocultures could change a high value landscapes lands, especially their biodiversity.

Polish government implemented a Polish Biogas Strategy, that establish uprise about two hundred of biogas plants. These biogas plants will consume average crops from about 10% of agriculture regions in every commune (Rama et al. 2013). Before planning and building biogas plant there should be considered such elements as commune specification(rural, industrial, urban), availability of substrates for biogas production (slurry, sewage sludge, biomass, biowastes), landscape condidtions, distance from heat receiver and shore of electricity.

In Poland only about 50% of garbage dump are adapted to utilize biowastes. It is a good proof that another 50% of biowastes are not threated in proper way. This amounts create a good opportunity for use them in anaerobic digestion process that could be profitable and enviromental friendly pathway.

REFERENCES

1. DUBLEIN D., STEINHAUSER A. Biogas from waste and renewable resources. Wiley-VCH 2006.
2. RAMA R., BOROWSKI S., DULCET E. Biogazownie rolnicze konkurencją dla rynku żywności. Inż. Ap. Chem. 2013, 52, 2, 60-61.

ANAEROBIC DIGESTION OF MICROALGAL BIOMASS

Ewa Kwietniewska, Jerzy Tys

Department of Physical Properties of Plant Materials
Institute of Agrophysics Polish Academy of Sciences
Doświadczalna 4, 20-290 Lublin, Poland
e.kwietniewska@ipan.lublin.pl

As fossil fuel stock seems to be depleted soon, alternative energy sources are constantly explored. Biogas production by anaerobic digestion is one of the most feasible ways for bioenergy generation. Anaerobic digestion is a process of decomposition of organic matter by a microbial consortium in an oxygen-free environment. As a result of this process, biogas, containing mainly methane and carbon dioxide, is produced. Various substrates are used for anaerobic decomposition, e.g. swine manure, municipal solid waste, fruit and vegetable wastes, maize silage and straw (Kwietniewska and Tys, 2014). Anaerobic digestion of various organic wastes works well e.g. in Germany which is undisputed leader in biogas production in Europe or in Sweden which is famous of biogas-supplied city buses (EurObserv'er, 2012). The technology is well known, it is used worldwide and functions successfully in industry for years.

Microalgal biomass as a substrate for anaerobic digestion is a quite new issue in science. Microalgae are unicellular microorganisms which photosynthesize. They can be cultivated using wastewater and flue gases-derived CO₂ in special devices - photobioreactors, in liquid medium. They absorb great amounts of CO₂, N and P during growth so the cultivation supports the environment. The great advantage of this type of biomass is that microalgae are capable of high growth rate and short doubling time, so high biomass production is possible during all year. Moreover, it is possible to acquire lipid-rich biomass of high heat of combustion value easily, by controlling environmental cultivation factors properly. For that reason, despite of a few inhibiting factors, the process of anaerobic digestion of microalgal biomass is viable. In comparison to other substrates, methane yields from microalgae are similar.

In the presentation, process of anaerobic digestion of microalgae will be discussed, some specific inhibition factors and also illustrative examples of achieved results will be demonstrated.

REFERENCES

1. EUROBSERV'ER. Biogas barometer. Systèmes solaires - le journal des énergies renouvelables n° 212 – 2012; biogas barometer– december 2012.
2. KWIETNIEWSKA E., TYS J., 2014. Process characteristics, inhibition factors and methane yields of anaerobic digestion process, with particular focus on microalgal biomass fermentation. *Renewable and Sustainable Energy Reviews* 34, 491–500.

ULTRASONIC PRE-TREATMENT OF LIGNOCELLULOSIC BIOMASS TO IMPROVE ANAEROBIC DIGESTION

Justyna Lalak

Department of Physical Properties of Plant Materials,
Institute of Agrophysics Polish Academy of Sciences
Doświadczalna 4, 20-290 Lublin, Poland
j.lalak@ipan.lublin.pl

Currently, one of the major conditions for sustainable development is the production of appropriate fuels from waste material, which can be utilized as an alternative to fossil fuels. Biogas produced from biomass is a promising renewable energy source, which is already used in the production of electricity and as a car fuel in many different countries. Lignocellulosic biomass contains cellulose, hemicelluloses and lignin and has the potential to be used as a raw material for biogas production. However, this type of biomass is not fully biodegradable in the methane fermentation process on an industrial scale due to its complex physical and chemical structure, which results in lower energy recovery in terms of methane yield. The biodegradability of the lignocellulose material can be increased by a pre-treatment. Many methods of pre-treatment have been studied. It can be carried out either physically, chemically or biologically, or as combinations of these (Lalak *et al.*, 2014).

Ultrasound can be used as a pre-treatment method for biomass. It is known to disintegrate sludge and disrupt microbial cell walls resulting in the release of soluble substance. But it also has a disintegrating effect on the lignocellulosic structure and speeds up the hydrolysis - the limiting step of anaerobic digestion (Aimin *et al.* 2005, Kwiatkowska *et al.*, 2011).

This article analyses the impact of using ultrasound in the pre-treatment of *Misthantus* on the biogas production as well as the potential of ultrasound to speed up the anaerobic digestion. The research material was obtained from Agricultural Experimental Station Osiny of the Institute of Soil Science and Plant Cultivation, Puławy, Poland. Ultrasonic pre-treatment was applied with various amplitude and treatment time settings. After pre-treatment, fermentation process was carried out in a 2 liter Biostat B-plus stirred tank reactor (Sartorius Stedim Biotech, Gottingen, Germany). The temperature of the process was 37°C. Biogas production was measured and analyzed for methane content and methane yield. An increase in ultrasonic amplitude and treatment time resulted in an overall

increase in methane production. It was found that ultrasound pre-treatment has an influence on the time of anaerobic digestion. No significant differences were noted in the quality of the biogas produced.

ACKNOWLEDGEMENTS

The study was carried out using equipment purchased as part of Regional Laboratory of Renewable Energy, Operational Programme Development of Eastern Poland 2007–2013.

REFERENCES

1. AIMIN T., HONGWEI Z., GANG Ch., GUOHUI X., WENZHI L., 2005. Influence of ultrasound treatment on accessibility and regioselective oxidation reactivity of cellulose. *Ultrasonics Sonochemistry*, 12, p. 467–472.
2. KWIATKOWSKA B., BENNETT J., AKUNNA J., WALKER G.M., BREMMER D.H., 2011. Stimulation of bioprocesses by ultrasound, *Biotechnol. Adv.*, 29, p. 768–778.
3. LALAK J., KASPRZYCKA A., MURAT A., PAPROTA E. M., TYS J., 2014. Pretreatment methods of lignocellulosic biomass to improve methane fermentation process. *Acta Agrophysica*, 21(1), p. 51-62.

CAPACITIVE THROUGHPUT SENSOR AND ITS SENSITIVITY TO THE CHANGE OF MATERIAL PROPERTIES

Jakub Lev

Department of Agricultural Machines,
Czech University of Life Sciences Prague
Kamýcká 129, 165 21 Praha 6 - Suchbátka, Czech Republic
jlev@tf.czu.cz

One of the earliest papers about throughput measurement with a capacitive sensor was published by Stafford *et al.* (1996). Authors used a capacitive sensor to determine grain mass flow. Other works were presented by Martel and Savoie (1999) and Savoie *et al.* (2002). Both papers deal with measurement mass flow rate through a forage harvester. The testing of the capacitive throughput sensors for potatoes, sugar beet, chopped maize and hops was presented in other papers (Kumhála *et al.*, 2009; Kumhála *et al.*, 2010; Kumhála *et al.*, 2013). Authors present that results are very perspective.

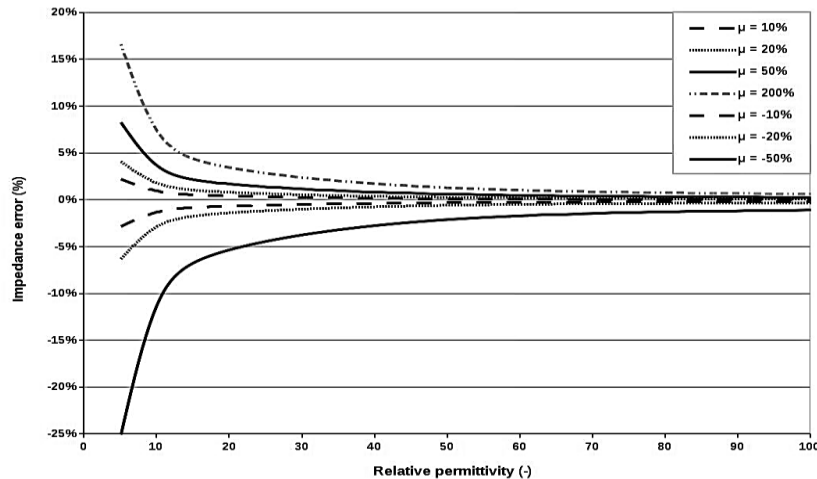

Fig. 1. The dependence between a relative permittivity of a measure material and impedance error for a different error of relative permittivity.

Capacitive sensors have been widely used for plant material moisture content determination (Osman *et al.*, 2002). Savoie *et al.* (2002) and Stafford *et al.* (1996) present that capacitive throughput sensors are sensitive to moisture content. However, Stafford *et al.* (1996) state on the base of their measurement that the sensor output was much less sensitive to moisture content than anticipated. Kumhála *et al.* (2009) present similar results. In the other article the measurement was presented where the influence of the moisture content was tested. The measurement was performed with four balsa blocks which were moistened to about 80% of moisture content and then slowly dried. On the base of the measurements it was presented that the capacitive throughput sensor was less sensitive to the higher moisture content. Nevertheless, authors did not explain the principle of that behaviour.

The main goal of this work is to clearly explain why and when capacitive sensor can be less sensitive to the changes of the material properties. Output sensor values directly depend on the sensor impedance and it is influenced by the electric field between electrodes. Most important quantities are the relative permittivity and the material loss tangent. In this work the calculation was carried out where the influence of the relative permittivity and the loss tangent were watched. It was found that the loss tangent of the material is not significant in majority cases.

Influence of the relative permittivity change was studied in the second step. Electric field of the sensor can be divided into two parts. One part represents the measure material and second part represents the air above material. This situation is possible to describe as two capacitors with different dielectric material (measure material and air). On the base of a simple theory a formula which describes relationship between the change of the relative permittivity and an impedance change of the sensor is possible to derive.

$$\delta_z = \frac{\varepsilon_{air} \cdot \mu}{(\varepsilon_m - \varepsilon_{air}) \cdot \left(1 + \frac{\mu}{100}\right)}, \quad (1)$$

where δ_z is relative error of the sensor impedance change (%), ε_{air} is the relative permittivity of air (-), μ is a change of the measure material relative permittivity (%) and ε_m is a relative permittivity of the measure material (-). In the Fig. 1 there are dependences between relative permittivity of the material and relative error of the sensor impedance change for different change of the material relative permittivity (μ). It is apparently that the relative error of the sensor impedance change is decreasing with increasing relative permittivity. However, it is logical that if the change of the relative permittivity is negative, the absolute value of the impedance error is bigger. These results mean that materials with higher relative permittivity are useful for capacitive throughput sensors. Also this behaviour can explain why the influence of the moisture is less significant for moister material because moister materials have higher relative permittivity.

REFERENCES

1. STAFFORD J. V., AMBLER B., LARK R. M., CATT, J. 1996. Mapping and interpreting the yield variation in cereal crops. *Comput Electr. Agric.* 14, p. 101–119.
2. MARTEL H., SAVOIE P. 1999. Sensors to measure forage mass flow and moisture continuously. ASAE paper No. 991050.
3. SAVOIE P., LEMIRE P., THÉRIAULT R. 2002. Evaluation of five sensors to estimate mass–flow rate and moisture of grass in a forage harvester. *Applied Engineering in Agriculture.* 18, p. 389–397.
4. KUMHÁLA F., PROŠE V., BLAHOVEC J. 2009. Capacitive throughput sensor for sugar beets and potatoes. *Biosystems Engineering.* 102, p. 36–43.
5. KUMHÁLA F., PROŠEK, V., KROULÍK M. 2010. Capacitive sensor for chopped maize throughput measurement. *Comput Electr. Agric.* 70, p. 234–238.
6. KUMHÁLA F., KAVKA M., PROŠEK V. 2013. Capacitive throughput unit applied to stationary hop picking machine. *Comput Electr. Agric.* 95, p. 92–97.
7. OSMAN A., SAVOIE P., GRENIER D., THÉRIAULT R. 2002. Parallel-plate capacitance moisture sensor for hay and forage. ASAE paper No. 021055,10 p.

DETERMINATION OF SURFACE FREE ENERGY OF PLANT LEAVES

Małgorzata Łukowska, Grzegorz Józefaciuk

Department of Physicochemistry of Agricultural Materials
Institute of Agrophysics Polish Academy of Sciences
Doświadczalna 4, 20-290 Lublin, Poland
m.lukowska@ipan.lublin.pl

Wettability of a surface, characterized by its water contact angle is a function of the surface free energy (γ). Size γ depends on the type of forces on the surface of a solid: always existing dispersive forces (type of London's) and the forces of polar nature (electrostatic attraction-repulsion between the ions, permanent dipoles, induced dipoles, hydrogen bridges and acceptor-donors). The value of γ of the liquid (γ_L) can be determined by direct methods, whereas for estimation of γ_S of solids many indirect methods have been designated, such as Fowkes, Owen-Wendt, Wu, Zisman, Neuman and van Oss-Chaudhury-Good method [1,2]. In this paper, the Owen-Wendt method was used. In this method γ is considered as a sum of two components: polar γ^P (consisting of the sum of all polar interactions) and dispersive γ^D [2]:

$$\gamma = \gamma^D + \gamma^P \quad (1)$$

Thermodynamic equilibrium for a drop of liquid L settled on a solid surface S is described by Young's equation:

$$\gamma_S - \gamma_{SL} = \gamma_L \cos \theta_c \quad (2)$$

where γ_S^L - interfacial surface free energy (solid / liquid), γ_L - liquid surface free energy, γ_S - surface free energy of solid, θ_c – contact angle of the liquid and the solid.

The aim of this work was to determine the influence of drought conditions during cultivation on surface free energy of the upper surface of leaves of four barley cultivars. Basic information describing the cultivars shows Table 1.

Table 1. Characteristics of barley varieties:

Sample No.	Name	Origin	Resistance to drought
1.	Sebastian	Poland	low
2.	Maresi	Germany	high
3.	Georgia	England	medium
4.	CamB1	Syria	high

Wettability of the leaf surfaces was determined by the measurement of static contact angles of 5 μ l (about 0.5mm diameter) droplets of water and diiodomethane using a microscope (DSA100, KRUSS) equipped with a goniometer and CCD camera. The measurements were done in 10 replicates.

For all investigated leaves the main component of γ_s is the dispersive γ_s^D one which accounts from 83 to 91% of the total γ_s value. The γ_s value of barley leaves is higher for plants grown under control conditions than in dry conditions. Drought stress generally decreases the contribution of the polar component γ_s^P to the total value of γ_s . Water contact angle θ increases in stressed leaves indicating that they are more hydrophobic than the control leaves.

The surface free energy γ_s can be an indicator characterizing both the impact of drought on plants and possibly the plant resistance to stress.

ACKNOWLEDGEMENTS

The investigations were done in the frame of Task 6 of the project „POLAPGEN-BD „Biotechnological tools for obtaining corn varieties high resist to drought” No UDA.POIG.01.03.01-00-101/08-02, co-financed by the European Regional Development Fund (ERDF) in frame of Innovative Economy Programm 2007-2013, Activity 1.3, Sub-activity 1.3.1.

REFERENCES

1. JAŃCZUK B., ZDZIENNICKA A., 1994, A Study on the Components of Surface Free Energy of Quartz from Contact Angle Measurements, *J. Mater. Sci.*, 1994, 29, 3559-3564.
2. JAŃCZUK B., BIAŁOPIOTROWICZ T., ZDZIENNICKA A., 1999, Some remarks on the components of the liquid surface free energy *J. Coll. Interface Sci.*, 211, p. 96.

HIGH DIETARY FIBER POWDER ENRICHED WITH METAL IONS AND ASCORBIC ACID AS A MODIFIER OF RHEOLOGICAL PROPERTIES OF FOOD

Joanna Mierczyńska, Justyna Cybulska, Artur Zdunek

Department of Microstructure and Mechanics of Biomaterials, Institute of Agrophysics Polish Academy of Sciences, Doświadczalna 4, 20-290 Lublin, Poland
 jmierczynska@ipan.lublin.pl

The study of rheological behavior is widely used in food processing as well as in assessing the quality and acceptability of food by consumers. The knowledge of the rheological characteristics of food components can predict their behavior during the various stages of processing.

The aim of this work was to determine rheological properties of a polysaccharide matrix enriched with the addition of calcium, magnesium, iron and ascorbic acid as a potential modifier of food products.

Above 90% of cell wall dry weight is composed of polysaccharides consisting of three major components – pectin, cellulose and hemicelluloses, which are parts of dietary fiber.

The mixture of cell wall polysaccharides is composed of apple pomace freeze dried and micronized to particle size 50-100 μm and apple pectin spray dried with a low degree of methylation. Optimized mixture of modified cell wall polysaccharides was enriched with calcium, magnesium and iron ions and ascorbic acid. It has been announced that dietary fiber has a positive effect on health. Also the addition of ascorbic acid such as micro- and macronutrients can be used as supplements of diet. In the modification of the rheological properties of food enriched with a polysaccharide matrix with metal ions and ascorbic acid we used the ability of low methoxyl pectin chains to interact with calcium cations. When the galacturonic acid residues, which form galacturonan, are not methyl-esterified at C-6 carboxyl, they have a negative charge and they are able to interact with some divalent ions and form intermolecular network.

Our study proved a strong influence of calcium cations on rheological behavior of pectin-containing mixture of cell wall polysaccharides. Also, the addition of iron and magnesium ions and ascorbic acid improved rheological properties of cell wall polysaccharides' mixture such as viscosity and values of shear stress versus shear rate curves in comparison to the control - pectin-containing mixture without any ions.

ACKNOWLEDGEMENTS

This study was supported by the National Centre for Research and Development (Project No. 23/109/L-2/10).

REFERENCES

1. CYBULSKA J., ZDUNEK A., KONSTANKIEWICZ K., (2011). Calcium effect on mechanical properties of model cell walls and apple tissue. *Journal of Food Engineering*, 102, 217-223.

MEASUREMENT OF COLZA SEEDS CONDUCTIVITY

Ján Novák

Department of Physics,
Slovak University of Agriculture in Nitra
Tr. A. Hlinku 2, 949 76 Nitra, Slovakia
jan.novak1@uniag.sk

Study of electrical properties are important for predicting the behavior of a material in a electric field or for knowing how the presence of material may influence the field or an associated electrical circuit. Research of electric properties are finding utilization in a lot of technical applications. Results of measurements are used for determining the moisture content, the surface level of liquid and grainy materials, for controlling the presence of pests in grain storage, for the quantitative determination of mechanical damage and in many other cases (Hlaváčová). Electric properties of many biological materials have already been investigated. It was discovered that electric properties of these materials are very affected by moisture content of the material. Small quantities of adsorbed water may cause large changes in the electrical properties of hygroscopic materials.

Results of conductivity measurement depend of many factors. The most important are temperature, bulk density, mode of bond of water, measure of material homogeneity. On measurement of conductivity was used coaxial probe with brass electrodes. Probe was filled with constant valume of semples. Samples of seeds was in probe joggled without external force. Resistance of probe was measured using the multimeter. Sample conductivity σ was computed according to the following relation:

$$\sigma = \frac{\ln \frac{r_1}{r_2}}{2 \pi l R}$$

where:

- r_1 – radius of outer electrode
- r_2 – radius of inner electrode
- l – lenght of condensor
- R – resistance

The measurements were carried out at air temperature 20°C and atmospheric moisture 60 %. Following table contain values of moisture content ω and bulk density ρ of samples

Table 1. Moisture content ω and bulk density ρ of samples

ω (%)	6.0	10.7	17.2	24.2
ρ (kg.m ⁻³)	681	664	651	629

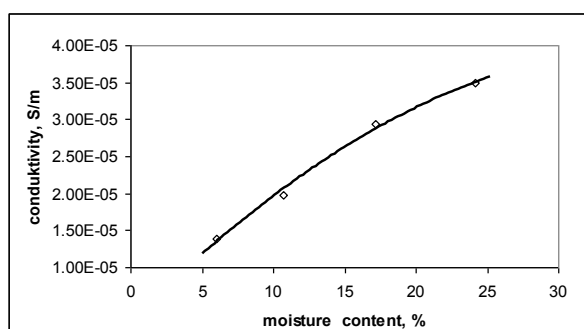
**Fig.1.** Conductivity dependance of moisture content for colza seeds.

Conductivity of colza seeds samples increase with moisture content of samples. This effect is caused by the improvement of conditions for electrolytic transport of charges by means of dissociated ions in damp medium. It is known that electric properties are also related to the bulk density of material. Therefore, to ensure the definitness of results, we have also stated the values of bulk density of samples.

REFERENCES

1. BERLINER J. 1973 Izmerenie vlažnosti. 1.vyd., Moskva: Energia, 180s.
2. HLAVÁČOVÁ Z. 1999 Niektoré elektrické vlastnosti semien laskavca. *Zemědělská technika*, 45,3, s.99-104.

THE POSSIBILITIES OF BIOGAS PRODUCTION IN THE LUBELSKIE PROVINCE

Marta Oleszek, Jan Kuna, Jerzy Tys

Department of Physical Properties of Plant Materials
Institute of Agrophysics Polish Academy of Sciences
Doświadczalna 4, 20-290 Lublin, Poland
oleszek@ipan.lublin.pl

In accordance with the government's plan developed by the Ministry of Economy, one biogas installation is expected to create in each Polish commune (Polish Ministry of Economy, 2010). This is due to the fact that, among all renewable energy sources, only biogas plants are able to provide a steady supply of energy throughout the whole year. Thanks to the cogeneration, in addition to the current, certain amount of heat is also produced, which can be resold. Furthermore, there are also biogas plants producing biomethane, which, after previous cleaning, can be pumped into gas grid or constitute a transport fuel (Lewandowski, 2012).

In view of the favorable soil and climatic conditions, The Lubelskie Province is a region of great importance of agriculture. It is believed that this sector's potential is not fully exploited. Therefore, its modernization and innovation is required. The development of non-agricultural activities in rural areas is very important, because too many people are employed in agriculture in comparison to other voivodship and the European Union. As one of the possible forms of non-agricultural activities in the Lubelskie Province the production of agricultural biogas is indicated (Marshal Office of the Lubelskie Voivodship, 2004).

In the Lubelskie Voivodship there are currently five biogas plants (Agricultural Market Agency, 2014), and several tens of them is at the project stage of varying degrees of advancement. The potential of the Lublin region in this respect seems to be higher, due to the presence of large poultry and swine farms and a considerable area of cultivated land in excess of 100 hectares. Slurry derived from these livestock farms, coupled with energy crops, would be a great resource base for newly created biogas plant. Unfortunately, it is rare that both of these materials are available simultaneously. In those poviats where there is a lot of farms, mostly there are not land for energy crops cultivation, because the whole area is allocated to the production of food for livestock. In addition to the proximity of feedstock, access to adequate infrastructure, ensuring reception of energy and the possibility of disposal of digestate are also very important. Sometimes may also happen that Local Spatial Development Plan becomes a barrier to investment, due to the fact that 22.7% of Lubelskie Voivodship is

covered by various forms of nature protection. Here are located Poleski and Roztoczański National Park and 16 landscape parks. In addition, there are numerous protected landscape areas, nature reserves, nature monuments.

According to the above, the actual potential of biogas production in Lublin region is estimated to be only about 42 MW, which means that it is unlikely to meet the assumptions of the Ministry of Economy and build a biogas plant in each of the 213 communes of Lubelskie Voivodship.

REFERENCES

1. AGRICULTURAL MARKET AGENCY. 2014. Registry of energy companies engaged in the biogas production. On-line: access 17.04.2014).
2. LEWANDOWSKI W., 2012. Proecological renewable energy sources. Warsaw: NWT Publisher (in Polish).
3. MARSHAL OFFICE OF THE LUBELSKIE VOIVODSHIP. 2004. Regional Innovation Strategy of the Lubelskie Voivodship. Lublin: Marshal Office (in Polish).
4. ONISZK-POPLAWSKA A., MATYKA M., 2012. A comprehensive assessment of conditions for the production of agricultural biogas in the Lubelskie Voivodship. Lublin: Department of Economy and Innovation of the Marshal Office in Lublin (in Polish).
5. POLISH MINISTRY OF ECONOMY. 2010. The directions of development of agricultural biogas plants in Poland in 2010-2020. Warsaw: Ministry of Economy (in Polish).

APPLICATION OF PCR METHOD FOR DETECTION OF HEAT-RESISTANT FUNGI BELONG TO THE *Talaromyces flavus* SPECIES

Panek Jacek, Frąc Magdalena

Department of Soil and Plant System,
Institute of Agrophysics Polish Academy of Sciences
Doświadczalna 4, 20-290 Lublin, Poland
j.panek@ipan.lublin.pl, m.frac@ipan.lublin.pl

In recent years problem of heat-processed food spoilage have been reported repeatedly. Primary source of this spoilage are heat-resistant fungi. They are able to survive heat-treatment during process of pasteurization and grow in microaerobic and anaerobic conditions during storage. Ones of the most common sources of pasteurized and canned fruit products spoilage are fungi belong to the

Talaromyces flavus species. Heat-resistant fungi occur in natural conditions mainly in soil and can contaminate fruit near the ground.

Talaromyces flavus apart from food spoilage is able to produce numerous secondary metabolites, such as talaromycin or mitrorubrin.

Detection of heat-resistant fungi in fruit material or fruit product can be conducted by usage of traditional plate methods and microscope based techniques or by using techniques based on molecular biology.

Traditional agar plate methods in detection of heat-resistant fungi are time consuming and sometimes can be inaccurate. On the contrary, molecular biology based, such as Polymerase Chain Reaction – PCR, methods can overcome those problems. PCR uses specific designed primers and heat-stable DNA polymerase to amplify the target DNA region.

The aim of this study was to develop and optimize the PCR reaction for detection of *Talaromyces flavus*.

ACKNOWLEDGEMENTS

The research is funded by the Polish Ministry of Science and Higher Education under the Diamond Grant program.

REFERENCES

1. AMAEZE N.J., UGWUANYI J.O., OBETA J.A.N., 2010. Studies Of Heat Resistant Fungi In The Soil: *Talaromyces flavus* Isolated In Nigerian Soils. *New York Science Journal*, 12, 8–14.
2. JESENSKÁ Z., PIECKOVÁ E., BERMÁT D., 1993. Heat resistance of fungi from soil. *International journal of food microbiology*, 19, 187-192.
3. Proksa B., 2010. *Talaromyces flavus* and its metabolites. *Chemical Papers* , 64, 696–714.
4. SOKOŁOWSKA B., 2010. Pleśnie ciepłooporne w przetwórstwie owoców i warzyw. *Przemysł fermentacyjny i owocowo-warzywny*, 10, 36-37.

THE INFLUENCE OF THE ORGANICAL SLUDGES ON HYDROPHYSICAL SOIL PROPERTIES

Tomasz Pastuszka, Cezary Sławiński

Department of Metrology and Modelling of Agrophysical Processes,
Institute of Agrophysics Polish Academy of Sciences, Doświadczalna 4, 20-290 Lublin, Poland
t.pastuszka@ipan.lublin.pl, c.slawinski@ipan.lublin.pl

Hydrophysical soil properties such as soil water retention and water conductivity coefficient have an impact on the growth and yield of crops. Sludges from biogas installations, fruit wastewater treatment plant and dairy sludge, which contain organic matter could be used as an addition to soil. They can modify biological, chemical, physical and also hydrophysical properties of soil. The organic matter and macro and micro elements contained in organic sludges ensure that plants have access to the necessary nutrients. However, it is essential to verify the impact of particular waste on soil environment.

In this work, the studies on hydrophysical properties of the soil containing organical sludges from above mentioned sources are presented. Undisturbed soil samples have been taken from the experimental field to determine properties such as particle size distribution total porosity, retention curve and hydraulic conductivity coefficients both in saturated and unsaturated states. Measured parameters of the tested samples are used as parameters in the physical model to predict soil moisture. Thanks to this it is possible to estimate the impact of sludges on the real conditions of growth plant.

Studies have shown small differences between fields with different amount of sludge application and the untreated control field. The studies are scheduled for two years to investigate the effects in the longer term effect.

APPLICATION OF HYPERSPECTRAL IMAGING TO ESTIMATION OF PROTEIN AND WATER CONTENT OF SELECTED GRAINS

Joanna Pastuszka-Woźniak, Piotr Baranowski

Department of Metrology and Modelling of Agrophysical Processes,
Institute of Agrophysics Polish Academy of Sciences, Doświadczalna 4, 20-290 Lublin, Poland
jwozniak@ipan.lublin.pl, pbaranow@ipan.lublin.pl

Quality of foods is generally controlled with traditional methods such as microbiological and chemical tests. However, the necessity of a non-destructive,

rapid and accurate on-line method to monitor the product quality and safety is topic of many research studies.

Grain moisture and protein content affect the processing, storage and technological value of grain. The objective of this study was to investigate the use of hyperspectral imaging system in range 400-2500 nm to predict water and protein content in the grains of oilseeds like sunflower, rape and soybean as well as cereal plants like wheat and barley.

Hyperspectral imaging provides both spatial and spectral information about the analyzed object. This technique can be used to analyze both individual kernels and bulk samples. In grain quality evaluation this technique has been experimented with for moisture and oil content prediction in corn (Cogdill *et al.*, 2004), detection of fungi in wheat (Delwiche *et al.*, 2011), and detection of insect damage in wheat (Singh *et al.*, 2009).

The present study has focused on the development of algorithms for the analysis of spectral characteristics of plant raw materials to identify the most important wavelengths for predicting moisture and protein content in samples. The water content and protein content in the samples were determined by conventional methods. The relationship between grain reflectance spectra and corresponding individual chemical properties was determined using the multivariate regression model. The results of this study demonstrated that hyperspectral imaging system is a promising technique to predict the protein and water content in grains.

REFERENCES

1. COGDILL R.P., HURBURGH J.C.R., RIPPKE G.R., BAJIC S.J., JONES R.W., MCCLELLAND J.F., JENSEN T.C., LIU J., 2004. Single kernel maize analysis by near-infrared hyperspectral imaging. *Transactions of the ASAE* 47, 311–320.
2. DELWICHE S. R., KIM M. S., DONG Y., 2011. Fusarium damage assessment in wheat kernels by Vis/NIR hyperspectral imaging. *Sensorry and Instrumentation for Food Quality* 5, 63–71.
3. SINGH C.B., JAYAS D.S., PALIWAL J., WHITE N.D.G., 2009. Detection of insect-damaged wheat kernels using near-infrared hyperspectral imaging. *Journal of Stored Products Research* 45, 151–158.

THERMAL CHARACTERISTIC OF ACACIA HONEY'S DIELECTRIC PERMITTIVITY

Bartosz Paszkowski

Department of Metrology and Modelling of Agrophysical Processes,
Institute of Agrophysics Polish Academy of Sciences
Doświadczalna 4, 20-290 Lublin, Poland
b.paszkowski@ipan.lublin

The complex impedance of a sample-sensor setup describes the behaviour of the tested material in an alternating electric field. The impedance spectroscopy is an experimental technique relying on recording changes of the tested material impedance, which result from frequency variations of an applied voltage signal (Barsoukov *et al.*, 2005). The information contained in the frequency spectrum of impedance of the analysed sample can be correlated with its physical and chemical parameters, which may serve as indicators of the material quality (Nelson, 2010).

The aim of this study was to determine the dielectric permittivity of acacia honey in the frequency range 20 Hz - 2 MHz and determine its dependence on temperature from measured impedance spectra.

The acacia variety of honey was selected for the research because it sustains its liquid phase for a long period of time and crystallizes slowly due to high fructose content (Popek, 2002). The examined honey was collected in the Lublin area in the year 2011.

The dielectric properties of the material determine its interaction with the electric field. In order to describe the dielectric properties, the calibration of the measurement circuit are needed. The model which describes the circuit is defined by the formula:

$$1/Z_M = 1/Z_0 + 1/Z_S \quad (1)$$

where Z_M is the measured impedance, Z_0 represents the impedance of the connector and the impedance of the part of the sensor which is never immersed in a sample, and Z_S is the impedance of the measured sample. The complex dielectric permittivity is obtained by dividing the impedance Z_{air} in air of the part of sensor which is immersed in the sample by the impedance of the sample Z_S obtained from equation (2), i.e.

$$\epsilon^* = Z_{air}/Z_S \quad (2)$$

The values of Z_{air} and Z_0 were calculated together with the value of Z_S using the system of equations (1) and (2), provided that the former was written both for air and transformer oil with known dielectric properties. The presented method for the measurement data processing was validated using materials of known dielectric permittivity, i.e. pure water, methanol, ethanol and isopropyl alcohol. The real and imaginary parts of complex dielectric permittivity of honey as functions of frequency within the investigated range of ambient temperatures stabilized during the experiment are presented in Fig. 1.

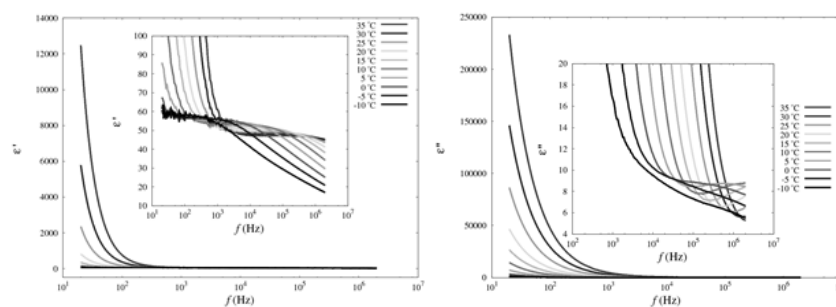

Fig. 1. The frequency dependence of the real part (left) and the imaginary part (right) of dielectric permittivity at various temperatures.

ACKNOWLEDGEMENTS

The research was supported by the National Center for Research and Development (NCBR), grant no. PBS1/A9/12/2012.

REFERENCES

1. BARSOUKOV E.J., ROSS MACDONALD J. 2005. Impedance Spectroscopy Theory, Experiment, and Applications, New Jersey, Hoboken: John Wiley & Sons, Inc.
2. NELSON S.O. 2010. Fundamentals of Dielectric Properties Measurements and Agricultural Applications, Journal of Microwave Power and Electromagnetic Energy, 44, p. 98-113.
3. POPEK S. 2002. A procedure to identify a honey type. Food Chemistry, 79, p. 401–406.

MICROALGAL CELL DISRUPTION TECHNIQUES

Agata Piasecka¹, Izabela Krzemińska¹, Jerzy Tys¹, Jacek Wawrzykowski²

¹Department of Physical Properties of Plant Materials,
Institute of Agrophysics Polish Academy of Sciences
Doświadczalna 4, 20-290 Lublin
a.palcowska@ipan.lublin.pl

²University of Life Sciences in Lublin,
Faculty of Veterinary Medicine Department of Biochemistry
ul. Akademicka 12, 20-033 Lublin

Due to the presence of many valuable substances and biologically active compounds in the microalgal cells, microalgal biomass is used in many different sectors of the economy and areas of life. This biomass has proved to be an important source of lipids appropriate for biodiesel production. Extracting specific components and metabolites from microalgal biomass is often limited by its cell wall. The cell wall forms a protective barrier between the cell and the environment, which makes access to the interior of the cell difficult. The construction of cell wall makes microalgae less permeable and extremely resistant to extraction. The first required step of lipid extraction is to permit complete access to the internal components and facilitate the process of extraction. For this purpose, various methods of cell disruption are used. Current algal cell disruption methods can be classified into two categories, non-mechanical and mechanical [2].

Some examples of mechanical cell disruption include: solid shear (e.g. bead mill and press), liquid shear (e.g. high-pressure homogenization and ultrasonication) and others (autoclave, lyophilization and microwave). Non-mechanical methods are e.g. osmotic shock, acids or alkalis and enzymes [1].

The aim of this investigation is to identify an appropriate microalgal cell disintegration method applied before lipid extraction. To define the disruption success the absorption of samples before lipid extraction was photometrically measured. This method is based on measuring the absorbance at a wavelength of 280 nm which corresponds to three aromatic amino acids – phenylalanine, tyrosine and tryptophan [3]. As a result of cell wall destruction, the contents of the cells are released to the environment. The degradation of the cell wall is strongly correlated with the value of absorption. Additionally, this method allows us to determine the degree of fragmentation of the algal biomass prior to extraction.

REFERENCES

1. HALIM R., DANQUAH M.K., WEBLEY P.A. (2012) Extraction of oil from microalgae for biodiesel production: A review. *Biotechnology Advances*, 30, p.709-732.
2. SAFI C., URSU A.V., LAROCHE C., ZEBIB B., MERAH O., PONTALIER P., VACA-GARCIA C. (2014) Aqueous extraction of proteins from microalgae: Effect of different cell disruption methods. *Algal research*, 3, p.61-65.
3. SCHWEDE S., KOWALCZYK A., GERBER M., SPAN R. (2011) Influence of different cell disruption techniques on mono digestion of algal biomass. In: MOSHFEGH B. (Eds.) *World Renewable Energy Congress – Sweden, Volume 1, Bioenergy Technology*. Linköping: University Electronic Press, p.41-47.

ION EXCHANGE AND ADSORPTION PROPERTIES OF MODIFIED ZEOLITES

*Justyna Piasek, Karolina Kędziora, Justyna Szerement,
Anna Ambrożewicz-Nita*

Department of Physicochemistry of Agricultural Materials
Institute of Agrophysics Polish Academy of Sciences in Lublin
Doświadczalna str 4, 20-290 Lublin, Poland
j.piasek@ipan.lublin.pl

Zeolites are aluminum silicates of natural origin. They have porous structure, high specific surface area and high cation exchange capacity, that allow to use them as effective ion exchangers. Due to ion exchange and adsorption properties, zeolites are widely applied in environmental protection, agriculture, sewage and wastewater treatment, and adsorption of heavy metals (Margeta *et al.*, 2013).

For adsorption of metal ions: Cu^{2+} , Cd^{2+} , Zn^{2+} , Pb^{2+} , Co^{2+} , Mn^{2+} , Ni^{2+} , natural clinoptilolite or its hydrogen and sodium forms are most frequently used. Zeolites may be modified with metal cations, surfactants, metal oxides, or polymers that allows for wider applications. The type of modifying substance determines the type of adsorbates (Świdarska-Dąbrowska *et al.*, 2011). For anion adsorption, especially phosphate or nitrate which may cause eutrophication and/or other environmental problems (Huoa *et al.*, 2012) it is necessary to modify the surface of the mineral (Wang *et al.* 2010). For removal of nitrogen dyes, phenols or certain carcinogenic compounds zeolite is modified with surfactants. The most popular surfactant is HDTMA (hexadecyltrimethylamine), which not only enables

the adsorption of anions but also non-polar compounds (Wang *et al.*, 2010). Currently we conduct studies on modification of clinoptilolite with iron compounds to remove nitrates and phosphates from a municipal sludge.

ACKNOWLEDGEMENTS

This work was co-funded by the Project No IPBU.01.01.00-06-570/11-00 Developing an innovative model of the cross-border use of zeolitic tuff.

REFERENCES

1. ELSHORBAGY W., CHOWDHURY R. K. A., 2013. Water Treatment,
2. MARGETA K., ZABUKOVEC LOGAR N., ŠILJEG M., FARKAŠ Natural Zeolites in Water Treatment – How Effective is Their Use. InTech, p.81-112.
3. HUO H., LIN H., DONG Y., CHENG, H. - WANG, H. - CAO, L., 2012. Ammonia-nitrogen and phosphates sorption from simulated reclaimed waters by modified clinoptilolite. Journal of Hazardous Materials, 229-230, p. 292–297.
4. ŠWIDERSKA-DĄBROWSKA R., SCHMIDT R., SIKORA A., 2011. Właściwości fizykochemiczne zeolitu. Inżynieria Ekologiczna, 24, p.195-204.
5. WANG S., PENG Y., 2010. Natural zeolites as effective adsorbents in water and wastewater treatment. Chemical Engineering Journal, 156, p. 11–24.

BUILDING INTEGRATED WIND TURBINES

Petra Procházková

Faculty of Engineering,
Czech University of Life Sciences Prague
Kamýcká 129, Prague, Czech Republic
prochazkovap@tf.czu.cz

Wind energy is an important contributor to the ‘energy mix’ of the Czech Republic. According to Eurobarometr, the recent Czech Wind Energy Association’s research that focused on the public perception of the climate change and renewable sources indicates that we are not indifferent to the issue of climate change. 90% of Europeans consider it a serious problem. An interesting fact is that 85% of Czechs believe that the government should set targets for increasing the proportion of renewable energy sources such as solar or wind energy. On the other hand, research performed in the locality of Petrovice in Krušné Hory gave a different impression. Its purpose was to assess the negative perception of wind

turbines by the general public. Disruption of environment character came out as the most negative factor together with the decrease in property values caused by the construction process in the given locality (Fig. 1), [1].

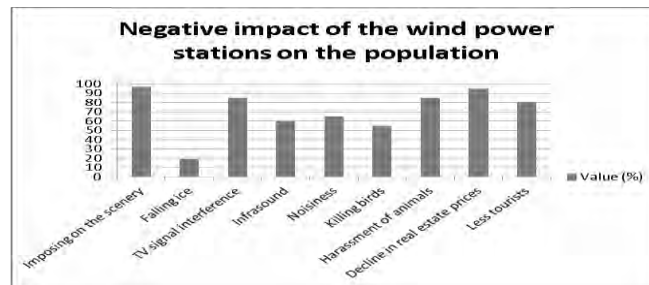

Fig. 1. Negative impact of the wind power stations on the population (reference: own research).

From a performance point of view, wind turbines generate from 300 kW for private use to 2 MW for mass electricity production. The Kosmas Chronicle states that the first documented windmill was installed in the Strahov Monastery garden in Prague in 1277. Wind turbines located in cities and especially in large building projects have formed and will form an important part in planning future installations [2].

Wind turbines integrated into the Bahrain World Trade Center are an example of a successful project. The Twin Tower complex is a 240-metre-high building with 50 floors commissioned in 2008. It is the first skyscraper with wind turbines integrated into the structure design. The turbines themselves have been developed, produced and installed by Norwin of Denmark. The turbines are expected to generate 10-15% of the electricity needed by both towers, which represents around 3.5% of the total project cost of \$150 million. The actual output per turbine is 225 kW. The planned electricity production of all turbines, with the wind and availability of data considered, is estimated as:

Turbine 1 - floor 17: 340-400 MWh / year

Turbine 2 - floor 27: 360-430 MWh / year

Turbine 3 - floor 37: 400-470 MWh / year

This represents a total production of 1100 to 1300 MWh, which corresponds to an average of 2900 kg/C in carbon emissions.



Fig. 2. Bahrain World Trade Center (reference: www.e-architect.co.uk).

The Strata Building in London commissioned in 2010 would be a more realistic example for the height of buildings designed in the Czech Republic. It is 148m high, featuring 43 floors that accommodate 408 apartments. The building utilises three wind turbines in its upper part with a rated output of 19 kW, thus dimensioned to generate 50 MWh annually and cover 8% of the building's electricity demand.

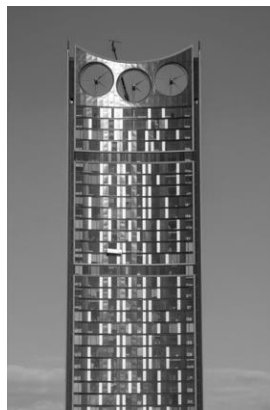

Fig. 3. Castle House London (Strata SE1) (reference: www.stratalondon.com).

The project of these parameters can be implemented in a future construction of development projects not only in the Prague.

ACKNOWLEDGEMENTS

I would like to thanks to companies Norwin and Czech Wind Energy Association for sharing those materials.

REFERENCES

1. SEQUENS E., HOLUB P., ŠTEKL J., ADAMOVSKEÝ R., PAŽOUT F., HUTLA P., SLADKÝ V., 2004. Větrné elektrárny: mýty a fakta: renewable energy and the environment. 1th ed., Brno: Hnutí Duha, Stavitel.
2. JANOŠKA M., 2003. Větrné mlýny v Čechách, na Moravě a ve Slezku. 1th ed., Praha : Libri.

EFFECT OF THE OSMOTIC PRETREATMENT FACTORS ON PHYSICAL PROPERTIES OF QUINCE (CYDONIA OBLONGA) DURING COMBINED DRYING

Milivoj Radojčin, Mirko Babić, Ljiljana Babić, Ivan Pavkov

University of Novi Sad, Faculty of Agriculture, Novi Sad
Trg Dositeja Obradovića 8, 21000 Novi Sad, Serbia
mradojcin@polj.uns.ac.rs, mbab@polj.uns.ac.rs
ljbab@polj.uns.ac.rs, ivan@polj.uns.ac.rs

Effects of osmotic pretreatment on some physical properties of quince is studied. Quince is rarely consumed fresh due to the hardness and pungency. Quince is mainly used for processing into compotes, jams, juices and brandy. As the dried product is used in mixtures of fruit teas. Paper is presented one way of the quince processing by drying, to obtain a product for direct consumption as a delicacy. Previous studies of combined technology, which consists of osmotic and convective drying, indicated that this technology is suitable for drying quince.

The native quince variety "Leskovačka" was used in the experiment. Fruits of this variety are apple-shaped and characterised by intensive aroma. Initial shape of samples for study of mechanical properties was sixths of quince. Initial shape of samples which were used for research of colour and volume changes were cubes dimensions 15x15x15 mm. Samples were pre-treated with sulphur dioxide. The amount of 1.0 g of technical sulphur per 1 kg of fruit material was used. The osmotic drying was performed in a sucrose and water solution. The temperatures of osmotic solution were 40 and 60°C, and the initial concentrations were 50 and 65°Bx. The osmotic drying lasted for 180 min. Measurements were conducted on every 20 minutes during osmotic drying.

Samples dehydrated with sucrose solution of 65°Bx had the lower moisture content at the end of the process. Moisture contents of quince osmotically pretreated in 50°Bx-40°C; 50°Bx-60°C and 65°Bx-40°C; 65°Bx-60°C sucrose solutions were 62.12, 58.72, 53.63 and 45.38% (w.b.), respectively. Highest solids gain 9.35% were observed at 60°C and 65°Bx sucrose solution. Lowest solids gain 5.5% were observed at 40°C and 50°Bx sucrose solution. Parameter of total color change ΔE^*_{ab} had been of high value when the quince samples were treated by osmotic solution concentration of 65°Bx. However, total colour change was less on the same samples after convective drying. Less changes of colour after convective drying is effect of higher amount of solute retained on the surface of the fruit. Mechanical properties of quince during osmotic drying are presented with force ratio $f=(F_o-F_i)/F_o$. Major changes f values were measured in the treatment with the solution temperature of 60°C. With these treatments there is a greater softening cubes of quince. The influence of osmotic solution temperature on f value during osmotic drying was determined. The volume change is represented with shrinkage SV. Shrinkage of quince samples varied from 0 to 53%, for different parameters of osmotic drying. Shrinkage increases with the increase of temperature and concentration of osmotic solution. Dependence in volume changes and the moisture content of quince can be described as linear model. Osmotic drying as a pre-treatment of convective drying positively affects physical properties of dried quinces.

ACKNOWLEDGEMENTS

This paper is a result of the research within the project TR31058, 2011-2014. financed by the Ministry of Education, Science and Technological Development of the Republic of Serbia.

REFERENCES

1. ABBOTT J.A., HARKER R.F., 2004. Texture. The horticulture and Food Research Institute of New Zealand Ltd. Mt. Albert Research Centre, Auckland, New Zealand.
2. BABIĆ LJ., BABIĆ M., 2003. Coupled osmotic and convective drying of apricot. *Journal on Processing and Energy in Agriculture (former PTEP)*, 7, p. 1-3.
3. BABIĆ M., BABIĆ LJ., PAVKOV I., RADOJČIN M., 2008. Changes in physical properties through osmotic drying of quince (*Cydonia oblonga* mill.). *Journal on Processing and Energy in Agriculture (former PTEP)*, 12, p. 101-107.
4. BOURNE M.C., 2002. *Food Texture and Viscosity*. (2nd ed.). Elsevier Science, London.
5. KOC B., EREN I., ERTEKIN F.K., 2008. Modelling bulk density, porosity and shrinkage of quince during drying: The effect of drying method. *Journal of Food Engineering*, 85, p. 340-349.
6. KROKIDA M.K., MAROULIS Z.B., - MARINOS-KOURIS, D. 1998. Effect of drying method on physical properties of dehydrated products. In *Proceedings of the 11th International Drying Symposium (IDS'98)*, Halkidiki, Greece.

MEASUREMENT OF DENSITY OF BIOOILS USING DENSITOMETER ANTON PAAR M 5000

Tomáš Regrut, Ana Petrović, Lubomír Híreš, Ján Csillag, Michal Valach

Department of Physics, Slovak University of Agriculture in Nitra
Tr. A. Hlinku 2, 949 76 Nitra, Slovakia
xregrut@is.uniag.sk

Introduction: The term density means numerically the mass of the volume unit of the substance at a given temperature. The density of oil is not the important functional feature, but it is important to characterize the oil in terms of its composition, to the mutual conversion volume and mass parameters and for calculating the kinematic and dynamic viscosity.

The density of homogeneous material is defined:

$$\rho = \frac{m}{V} \quad (1)$$

where:

ρ – density of body ($\text{kg} \cdot \text{m}^{-3}$),

m – total mass of body (kg),

V – Total volume of body (m^3) [1].

The density of substances of similar composition is additive property. Generally increases with the size of molecules and hydrocarbons from alkanes, through cycloalkanes to aromatics, the greatest density have asphaltic materials. From the density of the liquid lubricant we can infer to some extent on the composition (nature), but more precise after taking other physical characteristics, for example viscosity, boiling point, relative molecular mass [5].

Material and methods: For measuring the density, we used two ecological lubricants. First one was Mogul Hees 46, which is easily biodegradable hydraulic oil. It is designed especially for heavy duty high pressure hydrostatic systems, hydrogenerator equipped with high demands on oil antiwear effect (vane axial and ra-media piston) and its thermo-oxidative stability. The second one was Shell Naturele Fluid HF-E, which is an advanced hydraulic fluid for use in hydraulic and power transmission systems. It is easily biodegradable with a low ecotoxicity, and is particularly suited for use in environmentally sensitive areas. Fully synthetic esters, blended with ashless additives, provide Shell Naturelle Fluid HF-E with a superior blend of lubrication performance and environmental acceptability.

Density of organic lubricants was measured on the densitometer Anton Paar M 5000. During the measurement using densitometer the sample must meet certain conditions, such as temperature of samples should be constant and uniform throughout the whole volume of the sample, must be well mixed as well. The device electronically excites U-tube that simultaneously oscillates at the fundamental frequency and its harmonics frequency. Oscillatory characteristics are controlled by reference oscillator providing the accuracy rate. The reference oscillator is placed in thermal contact with the oscillating U-tube. This unique location allows compensate for any drift caused by thermal stress. Based on these measurements, the density is determined with extreme precision and at the same time will be corrected by the effect of viscosity.

Results: Mostly in the hydrocarbon lubricants density is about 860 kg m^{-3} to 980 kg m^{-3} . Synthetic lubricants except organosilicon chemical characteristic oil have the same viscosity and generally higher density, and over 1000 kg m^{-3} . The density of the liquid lubricant varies with temperature and pressure [4].

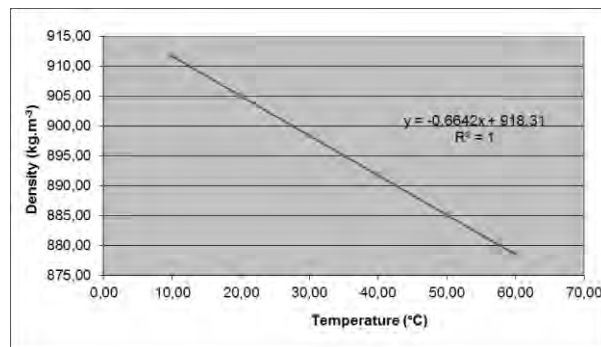

Fig.1. Temperature dependence of density for Mogul Hees 46.

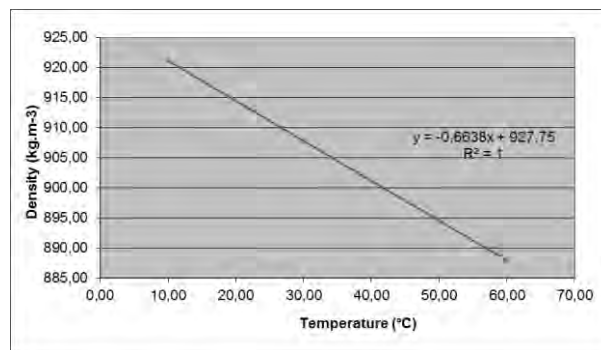

Fig.2. Temperature dependence of density for Shell Naturelle 46 HF-E.

From the graph we can see that with increasing temperature, the density of oils decreases and the curve has a linear downward trend.

Density dependence on temperature is described by the regression equation:

$$\rho = \rho_0 - k \frac{t}{t_0} \quad (2)$$

where:

ρ - density (kg m^{-3}),

ρ_0 – reference value of density (kg m^{-3}),

t – temperature ($^{\circ}\text{C}$),

$t_0 = 1^{\circ}\text{C}$.

The linearity of the curve is confirmed by the coefficient of determination $R^2 = 1$.

Conclusion: We measured density of organic lubricants with the densitometer Anton Paar M 5000. Based on the measured values and graphical dependencies, we can conclude that the density of the samples decreases with increasing temperatures. From the measured values, we built a temperature dependence of density. We approximate the dependencies with the linear regression equation. The coefficients of determination for regression equation (2) R^2 reached high values. As we can see from above graphical dependencies for samples of lubricants, the regression curve very well characterizes the line shape in this temperature range.

Experimentally measured values can serve as input to technological processes and were compared with the results stated by the producer which confirmed the accuracy of the results (for Mogul Hees 46 (2014) relative density is 910 kg m^{-3} at 15°C for 46 Shell Naturelle HF – E (2014) is 921 kg m^{-3} at 15°C). We can use this results as a basis for the examination of these types of lubricants required for the development of new technologies. The measured density values were obtained with good accuracy and dependency have obtained very high coefficients of determination. Linear regression equation (2) could be used for volumetric coefficient of thermal expansion calculation.

REFERENCES

1. HLAVAČOVÁ, Z. 2001. *Sorptive Properties of Pea Seeds*. Journal on Processing and Energy in Agriculture, 5, 2001(3), p.98-101, ISSN 1450-5029.
2. MOGUL HEES 46 (in Slovak). [online], [cit. 2014-04-09]. Available at: <<http://metalpro.kabel1.cz/cz-detail-1085327-mogul-hees-46.html>>.
3. SHELL NATURELLE HF-E 46. [online], [cit. 2014-03-19]. Available at: <<http://www.oilsandstuff.com/products/shell-naturelle-hf-e-46-20-litre>>.
4. ŠTĚPINA, V. – VESELÝ, V. 1980. Lubricants and special oils (in Czech). Bratislava: Veda. 696 p.
5. LAHUČKÝ, L. – TÓTH, T. 2005. Applied chemistry (in Slovak). SPU v Nitre. ISBN 8080695822. 149 p.

SINGLE AND DOUBLE DIODE MODELS OF PHOTOVOLTAIC CELLS: EVALUATION OF THE METHODS AND ACCURACY

Dani Rusirawan¹, István Farkas²

¹Department of Mechanical Engineering, Institut Teknologi Nasional (ITENAS) Bandung,
Jl. PKHH. Mustapa No. 23 Bandung 40124, West Java – Indonesia
danir@itenas.ac.id

²Department Physics and Process Control, Szent Istvan University
H-2100, Godollo Pater Karoly u.1., Hungary
Farkas.Istvan@gek.szie.hu

The fundamental building block of the photovoltaic (PV) systems is the PV cell. A simplified equivalent circuit diagram of the PV cell is used to illustrate the actual of PV cell since it is quite simple to implement and is compatible with the electrical behaviour of the actual PV cell. There are a number of more or less complex models for simulating the characteristic of a PV system (the current, I – voltage, V) for specific irradiance and temperature conditions. The I - V curve (as the PV main characteristics) is not only useful for the PV array and system simulation, but also as an analysis tool to gain an understanding of the internal physical mechanisms of the PV cell.

Many equivalent circuit diagram have been developed and proposed to describe the PV cell's characteristic and the most commonly used are single and double diode models. In a single diode model, a complete characteristic of a PV cell's can be described by five model parameters (called as five lumped parameters) i.e. light generated current (I_l), leakage or reverse saturation current (I_o), diode quality factor (n), series resistance (R_s) and shunt resistance (R_{sh}). I_l and I_o can be said as external influences meanwhile the others are an internal influences.

Figure 1 shows the equivalent circuit diagram based on single and double diode of PV cell models. The equivalent circuit diagram single diode model of PV cell consists of photocurrent source, a diode, a parallel resistor and a series resistor, meanwhile in double diode model, an additional diode have been included.

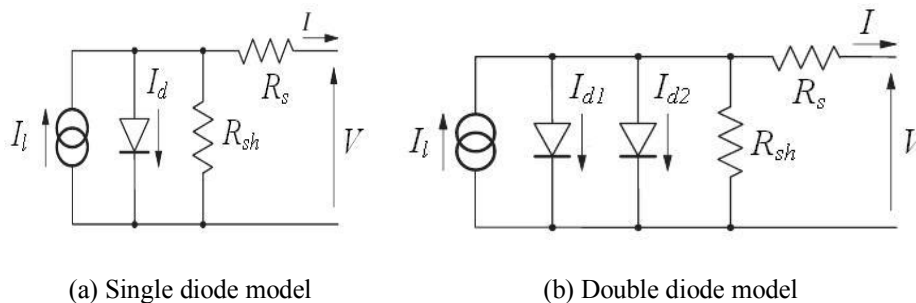

Fig. 1. Equivalent circuit diagram of PV cell.

An accuracy of the PV system modeling (simulation) is depending on the correct calculation of the parameters such as R_s , R_{sh} and n as well. These values are typically not provided by the PV cell producer and as consequently these parameters should be identified or calculated.

In this paper, comparison of single and double diode model of PV cell will be shown with emphasis on the methods and accuracy of both models. The involvement of, either external or internal parameters, are priority to be elaborated here.

A lot of methods can be implemented in order to determine all internal parameters. To further extract R_s , R_{sh} and n some complicated methods were proposed in the past years. In the literatures, many calculation methods such as genetic algorithm (GA), particle swarm optimization (PSO), simulated annealing (SA), explicit model, Lambert W-function, pattern search (PS), harmony search (HS) have been explained in order to identify a PV cell parameter, and generally built based on experimental of I - V characteristics through the extract parameters.

The degree of complexity of the model will determine which of the methods is most suitable in extracting the parameters that are involved in the mathematical expression of the model. Comparison of all methods that mentioned above will be discussed and evaluated in this paper.

Nevertheless, it should be pointed out that the motivation of this research is development of PV cell model, especially for polycrystalline silicon (wafer based crystalline silicon technology) and amorphous silicon (thin film technology) modules, as components of grid-connected PV array system at Szent István University (SZIU), which are not discussed in this paper.

ACKNOWLEDGEMENTS

This research was supported by Szent Istvan University, Godollo – Hungary through Hungarian Scholarship Board under Reference No. MÖB/138-2/2013, Institut Teknologi Nasional (ITENAS), Bandung, West Java – Indonesia, and OTKA K84150 Project.

REFERENCES

1. ASKARZEDAH A., REZAZADEH A., 2013. Artificial bee swarm optimization algorithm for parameters identification of solar cell models. *Applied Energy*, 102, p. 943–949.
2. DE BLAS MA., TORRES JL., PRIETO E., GARCIA A., 2002. Selecting a suitable model for characterizing photovoltaic devices. *Renewable Energy*, 25, p. 371–380.
3. GHANI F., DUKE M., CARSON J., 2013. Numerical calculation of series and shunt resistance of a photovoltaic cell using the Lambert W-function: Experimental evaluation. *Solar Energy*, 87, p. 246–253.
4. LI Y., HUANG W., HUANG H., HEWITT C., CHEN Y., FANG G., CARROLL D.L., 2013. Evaluation of methods to extract parameters from current – voltage characteristics of solar cells. *Solar Energy*, 90, p. 51-57.
5. MA T., YANG H., LU L., 2014. Development of a model to simulate the performance characteristics of crystalline silicon photovoltaic modules/strings/arrays. *Solar Energy*, 100, p. 31-41.
6. RUSIRAWAN D., FARKAS I., 2013. Identification of model parameters of the photovoltaic solar cells. Paper for Solar World Congress 2013, November 3 – 7, Cancun – Mexico.
7. RUSIRAWAN D., FARKAS I., 2013. Single diode model of photovoltaic modules and its parameters. Book of abstract 19th Workshop on Energy and Environment, October 24-25, Godollo – Hungary.
8. SCHUMACHER J., EICKER U., PIETRUSCHKA D., CATANI A., 2007. Exact analytical calculation of the one-diode model parameters from PV module data sheet information. Proceedings of 22 European Photovoltaic Solar Energy Conference (EU PVSES), September, Milano – Italy.

HYPERSPECTRAL IMAGING AS A TOOL FOR DETERMINING QUALITY AND PHYTOCHEMICALS CONCENTRATION IN SMALL FRUITS

Anna Siedliska

Department of Metrology and Modelling of Agrophysical Processes,
Institute of Agrophysics Polish Academy of Sciences in Lublin
Doświadczalna 4, 20-290, Poland
a.siedliska@ipan.lublin.pl

Small fruit is a group of fruits including berries, grapes, cherries and others which are small in size and have elastic properties for texture measurement. They are a rich source of phytochemicals such as total phenols, antioxidants and flavonoids which are important naturally occurring bioactive compounds, widely recognised for their potential health benefits to humans e.g. prevention of cancers, heart attack and Alzheimer's disease (Piljac-Zegarac and Samec, 2011). Postharvest storage of these fruits is often restricted to only a few weeks even under optimal temperature and humidity conditions. Moreover, they suffer colour change, softening, pitting and dehydration during storage (Linke *et al.*, 2010). The most important visible quality attributes during postharvest include colour, shape, and homogeneity, absence of fruit defect such as shriveling, fungal decay, and mechanical damage. Internal quality descriptors include sweetness, firmness, containing of flavonoids and antioxidants and the absence of insects.

Despite being a common practice, quality selection by hand is slow and unreliable, and its cost has increased over time. Therefore, the development of quick and reliable new technologies to assess the quality of small fruit on-line and without direct intervention is now necessary.

Hyperspectral inspection in the NIR range is based on the principle that substances absorb and reflect visible and near infrared radiation at characteristic wavelengths. This optical signature contains information about the most important chemical properties that are present and enables us to determine the internal and external quality of the small fruits.

The correlation between the optical signature and a series of quality parameters (sugar content, maturity, firmness, acidity) is analysed with chemometric techniques, which enable establishing reliable and accurate models for predicting the quality of fruits (Quin *et al.*, 2008). These techniques are non-destructive and require little or no sample preparation.

REFERENCES

1. LINKE M., HERPPICH W.B., GEYER M. 2010. Green peduncles may indicate postharvest freshness of sweet cherries. *Postharvest Biology and Technology*, 58(2), p.135-141.
2. PILJAC-ZEGARAC J., SAMEC D. 2011. Antioxidant stability of small fruits in postharvest storage at room and refrigerator temperatures. *Food Research International*, 44(1) p. 345-350.
3. QIN J., LU R. 2008. Measurement of the optical properties of fruits and vegetables using spatially resolved hyperspectral diffuse reflectance imaging technique. *Postharvest Biology and Technology*, 49(3), p. 355-365.

**THE INFLUENCE OF THE DAIRY SLUDGE ADDITION
ON THE SPECIFIC SURFACE AREA OF EUTRIC CAMBISOL
SOIL DEVELOPED FROM LOESS – THE ANALYSIS
OF WATER VAPOUR ADSORPTION ISOTHERMS**

Kamil Skic, Zofia Sokołowska

Department of Physicochemistry of Agricultural Materials
Institute of Agrophysics Polish Academy of Sciences in Lublin
Doświadczalna str 4, 20-290 Lublin, Poland
kskic@ipan.lublin.pl

The intensification of agriculture and increase in production of the food industry create, in addition to the expected products, significant amounts of different sludge (Mazur, 1996). Among them, mention should be made about organic sludge. They are solid or liquid residues with a high content of organic matter and generally with the preferred amount of nutrients. Soil irrigation gives the opportunity to solve the problems of their disposal, final purification or reuse (Brzezińska *et al.*, 2010). Organic sludge could have a positive effect on the quality of soil however, improper use can result in damaging soil environment including its surface properties. The analysis of the specific surface area (SSA) from data obtained from water vapour isotherm can describe the physicochemical changes during the sludge fertilization and may help in understanding processes leading to those changes.

In this work we would like to present the studies of water vapour adsorption on *Eutric Cambisol* soil developed from loess with addition of dairy sludge. The main aim was to examine its influence on the values of specific surface area.

The study was conducted for samples taken from depths of 5 to 20 cm and 20 to 40 cm, located on the research plots near the city of Krasnystaw in Poland. Two doses were used for fertilization (9 and 4,5 tons dry mass of dairy sludge per hectare). During two-year of the experiment samples were taken 8-times. The specific surface area was evaluated from adsorption isotherms data in the BET range of relative water vapor pressure, in accordance with the procedure described by the Polish Standard PN-Z-19010-1 for measuring the surface area of soil. The amount of adsorbed water vapour was computed as the difference between the weight of the sample with water and the dry sample (dried in an oven at 105°C).

The relations between the values of specific surface area, dairy sludge doses as well as soil depth were observed. The specific surface area for both layers decreased in relation to control samples and then after initial stress started to increase. Addition of dairy sludge led to reduction in SSA just after application. This effect was more noticeable in deeper layer where specific surface area decreased in relation to control samples by 52 and 62% for higher and lower dose respectively.

REFERENCES

1. BRZEZIŃSKA M., SOKOŁOWSKA Z., ALEKSEEVA T., ALEKSEEV A., HAJNOS M., SZARLIP P. 2010. Some characteristics of organic soils irrigated with municipal wastewater. *Land degrad. Develop.* Vol 22: p 586-595.
2. MAZUR T. 1996. Considering the fertilizing value of sewage sediments. *Advances of Agricultural Sciences Problem*, vol. 437: p. 13-22.
3. PN-Z-19010-1, 1999. Soil quality. Determination of the specific surface area of soils measurement by method of water adsorption. Polish Norms, Warsaw.

**APPLICATION OF THE FAST FOURIER TRANSFORM
METHOD TO THE TDR SIGNAL ANALYSIS BASED ON DATA
FROM A VECTOR NETWORK ANALYZER**

*Grzegory Solecki¹, Andrzej Wilczek¹, Agnieszka Szyplowska¹,
Anna Nakonieczna^{1,2}, Bartosz Paszkowski¹, Wojciech Skierucha¹*

¹Department of Metrology and Modelling of Agrophysical Processes,
Institute of Agrophysics Polish Academy of Sciences
Doświadczalna 4, 20-290 Lublin, Poland

²Institute of Physics, Maria Curie-Skłodowska University
Marii Curie-Skłodowskiej 5, 20-031 Lublin, Poland
g.solecki@ipan.lublin.pl

The Fourier transform is a linear transformation employed to transform signals between the time domain and the frequency domain. Discrete Fourier Transform (DFT) [1] is the Fourier transform defined for a discrete signal. DFT is a mathematical procedure used to determine the coefficients of the amplitude and phase of the harmonic frequencies of the analyzed discrete signal. Fast Fourier Transform (FFT) algorithm (and its inverse IFFT – Inverse Fast Fourier Transform) was devised in order to reduce the computation time of the DFT calculation algorithm by its division into shorter and simpler calculations.

The aim of this work was to extend the analysis capabilities of the reflected signals from the TDR (time-domain reflectometry) [2,3] probe using the FFT and IFFT method. The measurements were carried out using an FP/mts field probe and a multi-rod probe. Analysis of the scattering S_{11} parameter was conducted using the soil measurements performed using a vector network analyzer (VNA) in a frequency domain for ten levels of soil moisture. Software procedures developed in MATLAB allowed to transform the obtained S_{11} parameter to the time domain using IFFT method for an arbitrarily defined tabular electrical pulse. The correct operation of the software using the FFT method to extend the capabilities of signal analysis based on the data obtained from the VNA was verified. The developed procedures allow for a comparison of the sensitivity and measurement accuracy of soil moisture probes of different geometrical parameters and using user defined different TDR pulses. The measurements for the field probe and the multi-rod probe showed better sensitivity and accuracy of moisture measurements of the field probe.

ACKNOWLEDGEMENTS

This work was co-funded by the National Centre for Research and Development in the frame of the Applied Research Programme, grant no. PBS1/B9/5/2012.

REFERENCES

1. OPPENHEIM A. V., SCHAFER R. W., BUCK J. R., 1998. Discrete-time signal processing, New Jersey: Prentice Hall, Upper Saddle River.
2. SKIERUCHA W., WILCZEK A., ALOKHINA O., 2008. Calibration of a TDR probe for low soil water content measurements, Sensors and Actuators A: Physical, 147, p. 544-552.
3. ROBINSON D. A., JONES S. B., WRAITH J. M., OR D., FRIEDMAN S. P., 2003. A review of advances in dielectric and electrical conductivity measurement in soils using time domain reflectometry, Vadose Zone J., 2, p. 444-475.

THE ANALYSIS OF PRIMING EFFECT IN SOIL CONTAMINATED BY SELECTED PETROLEUM SUBSTANCES

Wioleta Stelmach

Department of Natural Environment Biogeochemistry,
Institute of Agrophysics Polish Academy of Sciences
Doświadczalna 4, 20-290 Lublin, Poland
w.stelmach@ipan.lublin.pl

One of the major environmental problems is pollution of soil by petroleum substances. Therefore, one of the issues related to environmental protection is the assessment of the potential ability of soil to biodegrade this contamination. To determine this ability of soil the *priming effect (PE)* can be used. The *PE* are defined as short-term changes in the turnover of soil organic matter caused by the treatments (usually addition of organic C) to the soil (Kuzyakov *et al.*, 2000).

The aim of the study was to compare the changes in turnover of soil organic matter (SOM), expressed by *PE*, after adding two different petroleum substances. In this experiment unleaded 95-octane petrol and diesel were used to contaminate soil. The polluted soils were incubated in glass containers, at 25°C under moisture condition optimal for plant growth. During the incubation the concentration and isotopic composition of CO₂ (emitted from the soil) were monitored. Gas chromatography (GC) and the IRMS (Isotope Ratio Mass Spectrometry) were used for the analyzes.

The data show that the dynamic of biodegradation of these substances in soil were different (Fig. 1). In the case of soil contaminated with gasoline a sharp increase in CO₂ concentration (up to 255 mg C-CO₂ kg⁻¹) to the seventh day of incubation was observed. After the 7th day no changes in the concentration of CO₂ were noticed. Another situation was observed in the case of soil with diesel contamination. The addition of diesel to the soil caused the continuous increase in CO₂ concentration until 42th day of the incubation. The final CO₂ concentration in the case of soil contaminated with gasoline and diesel achieved: 266.98 (± 3.98) and 407.06 mg C-CO₂ kg⁻¹ (± 7.94), respectively (Szarlip *et al.*, 2014).

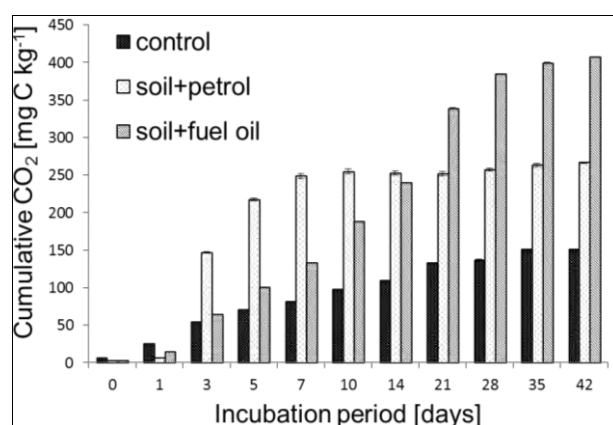

Fig. 1. Cumulative concentration of CO₂ evolved from soil contaminated with petroleum substances. Bars show standard errors of the means (n = 3).

The arisen carbon dioxide can be derived from two different origins: the decomposition of native soil organic matter or the decomposition of added petroleum substances. In order to specify the source of CO₂ the isotopic composition of this gas has been analyzed. The *PE* was calculated by using a mass-balance equation on the basis of analyzes of CO₂ concentration and isotopic composition of this gas.

REFERENCES

1. KUZYAKOV Y., FREDEL J. K., STAHR, K., 2000. Review of mechanisms and quantification of priming effect. *Soil Biology and Biochemistry*, 32, p. 1485-1498.
2. SZARLIP P., STELMACH W., JAROMIN-GLEŃ K., BIEGANOWSKI A., BRZEZIŃSKA M., TREMBACZOWSKI A., HAŁAS S., ŁAGÓD G., 2014. Comparison of the dynamics of natural biodegradation of petrol and diesel oil in soil. *Desalination and Water Treatment*, DOI:10.1080/19443994.2014.883777, p. 1-8.

**THE EFFECT OF CADMIUM IONS TO CHANGE
THE SURFACE CHARGE OF CELERY (*Apium* L.)
AND PARSNIP (*Pastinaca sativa* L.) ROOTS**

Justyna Szerement, Alicja Szatanik-Kloc

Department of Physicochemistry of Agricultural Materials
Institute of Agrophysics Polish Academy of Sciences in Lublin
Doświadczalna str 4, 20-290 Lublin, Poland
jszerement@ipan.lublin.pl

Cadmium soil contamination is a significant risk of contagion of plants. Although cadmium is an unnecessary element (its role in the physiology of plants is not yet well enough understood), plants absorb cadmium ions relatively easily. Cadmium is mainly taken up by the roots, in direct proportion to its concentration in the soil solution and then relatively easily transported to the aerial parts. Crops intended for consumption (e.g. root vegetables and cereals) tend to have a high tolerance for this element. However this may be associated with the risk of introduction of cadmium into the human diet. Stress occurring due to the toxicity of cadmium in the roots growth environment affects both metabolic and physiological processes, as well as anatomical and morphological changes of the plant (Alcantara et al. 2001). These changes lead to a clear setback of the primary functions of roots - uptake and transport of water and ions. From the physicochemical process point of view the cation exchange capacity (CEC) is primarily responsible for downloading the ion by the root (Szatanik-Kloc, 2010).

The aim of the study was to determine the effect of cadmium on changes in CEC. The CEC measurements were carried out on the basis of the potentiometric titration method. Studies have been conducted on the roots of two species of plants belonging to the family Apiaceae -celery (early variety Talar) and parsnips (early variety Hollow Crown). The growth and development of plants in water cultures were performed with strictly controlled composition and the pH of the medium in the 24 h cycle 16/8 hours (day/night) and at a temperature of 296 K (day) and 289 K (night). Cadmium was added to the medium in the form of a solution of $\text{CdCl}_2 \cdot 2,5 \text{H}_2\text{O}$ at concentrations of 20, 40 $\text{mg} \cdot \text{dm}^{-3}$ in the 8th week of the experiment. The incubation period under conditions of stress was 14 days. After this period, the plants were collected; based on the potentiometric titration process the curves of the variable surface charge depending on the pH of the roots of the plants examined were marked.

It was discovered that CEC of the plants' roots exposed to stress decreased in relation to the roots that grew in the environment without cadmium ions. A very

significant statistical decrease of the CEC was observed in the Parnship root, which grew at a concentration of cadmium 40 mg dm^{-3} .

REFERENCES

1. SZATANIK-KLOC A., 2010. Zmiany właściwości powierzchniowych korzeni wybranych roślinjednoliściennych i dwuliściennych determinowane fitotoksycznością glinu i miedzi. Acta Agrophysica Rozprawy i Monografie, 176(1), 1-122.

SOLAR COOLING WITH ABSORPTION COOLER IN HUNGARY

Attila Szilágyi¹, István Seres²

¹Department of Vehicle and Agricultural Engineering, College of Nyíregyháza
Sóstói út 31/B., 4400 Nyíregyháza, Hungary
szilagya@nyf.hu

²Department of Physics and Process Control, Szent István University
Páter Károly út 1., 2103 Gödöllő, Hungary
Seres.Istvan@gek.szie.hu

Nowadays in summer the air conditioning systems' energy consumption is comparable to the energy consumption of the heating systems in winter. This energy demand means that the fossil fuel power plants are producing more power in Hungary. In summer this plants give more power and more emissions. So this emissions generate several environmentally effects, for example global warming, air pollution, etc.

We can reduce the power plants' emissions with the utilization of renewable energy sources. The utilization of the solar energy is given a good possibility for us, as we can use this energy for cooling. There are two forms of the solar energy utilization, which are the power production with solar photovoltaic cells and heat production with solar collectors. The first option can be used for cooling by operating electrical air conditioner systems, powered by solar electricity. However surprising, even the solar collectors produced heat can be used for cooling, the absorption cooling units can utilize the heat of them. The main advantage of the solar cooling is that the energy demand and the energy production are at the same time, so there is no need for energy storage.

The solar cells and collectors are able to ensure the energy needed directly in the necessary time for the cooler and for the other air conditioning devices, for example fan and water pump. With this application we can save costs, energy,

because we do not use fossil fuels, and reduce our environmental pollutions and the global warming's human effects.

However there are some industrial solutions for the solar cooling, the households' utilization is not solved yet. For this purpose a solar collector or a solar cell combined with an absorption chiller could be a proper solution. An experimental unit is under construction in the Department of Physics and Process Control, Szent István University, Gödöllő. A absorption cooling system was installed to a unit, which is operated (heated) by the electrical energy of the solar cells, installed at the department.

A heat exchanger was installed to the cooler's output (the heat exchanger was developed and constructed in the framework of the project). The heat exchanger operates by liquid (solar liquid is cooled down by the absorption cooler unit), and the cool liquid is used for chilling down the air temperature of the air conditioned room. For as a heat exchanger between the solar liquid and the air a car's front cooler is used (a heat exchanger with a fan).

The photo of the constructed unit can be seen in Fig. 1.

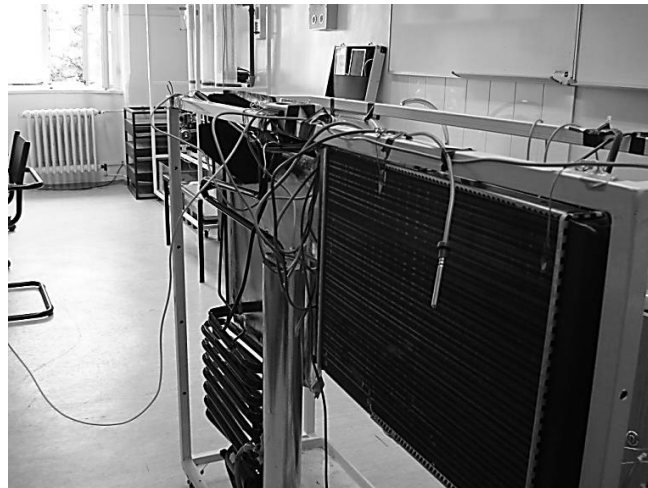

Fig. 1. Absorption cooler with heat exchanger.

During the tests the transfer fluid was water, but in the finals system propylene glycol is planned to be used. The heating and the cooling power are depend on following main parameters: the fluid flow rate, the difference of temperatures and the specific heat of the cooled medium.

During the setup a measurement system was installed to the system as well. At this moment the fluid flow rate was measured by operating the pump for a given time, and the volume of the pumped liquid was measured. From these

parameters the flow rate can be get. For the different temperature measurements (temperature of the solar liquid at the entrance and outcome of the heat exchangers, the temperature of the air before and after the fan), a computer based data logger was programmed, the software displays (value and graph) and saves the measured values. For the programming the Labview software was used, the AD converter is a National Instrument NI USB 6009 unit. For temperature sensors NTC 10K thermistors are used in a bridge connection (the bridge connection had to be used as the unit can measure just voltage signal and not measure directly resistance).

In the presentation the construction of the unit and the first measurement results will be presented.

ACKNOWLEDGEMENTS

This work was supported by Doctoral School of Engineering, Szent István University, Gödöllő, Hungary.

REFERENCES

1. ZSEBIK A., CSATA Zs., TORMA J., VÁRADI SZ., MOUMOULIDIS, I., 2010, Heating and Cooling with Solar Energy, *Energiagazdálkodás*, 2010/2., pp. 3-8. (in Hungarian).
2. HENNING H. M., WIEMKEN E., Solar cooling, Proceedings of ISES World Congress 2007 (Vol. I – Vol. V), 2009, pp. 60-67.
3. P. K. Nag, 2005., Engineering Thermodynamics, Tata McGraw-Hill Education
4. IAEA Technology roadmap, Solar heating and cooling, 2012, Paris, France.

EXAMINATION OF FROZEN WATER SAMPLES WITH FRACTAL ANALYSIS

Piroska Vig

Department of Physics and Process Control,
Szent István University, H-2103 Gödöllő, Páter K. 1., Hungary
Vig.Piroska@gek.szie.hu

Just as no two snowflakes are the same, when the water is frozen the pattern appearing in the ice are different, but they have a typical, source specific characteristics. The aims of the present work is determination the fractal dimension of air bubble patterns in the frozen water, and examination whether

there is a relationship between the fractal dimension and water types which were gathered from different sources.

The studied water samples were collected in Gödöllő area, Hungary. The types of waters are rain water, tap water, spring water and as a reference distilled water. After collection of the samples, they were poured in beakers, closed with clingfilm and put in the refrigerator, where they were frozen. The temperature field started at $-3.4\text{ }^{\circ}\text{C}$ at the top and the gradient was $9.3\text{ }^{\circ}\text{C/m}$ from top to down. Due to the slow, smooth freezing in the transparent ice block patterns appear that are unique, however are water type specific. During the freezing the ice grows from the top to down. The crystal growth still contains small inhomogeneities, in the spaces between the crystals are trapped air bubbles from the water. As the thermal conductivity and heat transfer coefficient are different in case of air, ice and water, so usually the air bubbles are not isolated, but they are arranged in needle-like shape. Downward the spikes appear more frequently, and finally with solidification of the air richest bottom part finished the freezing process. So, in the ice the air bubbles draws 'hedgehog' patterns, which are added at different water samples with special characteristics.

Rainwater pattern contains many densely situated pin. In the case of tap water, these pins are located less. The air bubbles in spring water to form softer line spikes, while freezing of distilled water structuring in the perpendicular direction of the freezing also observed.

To determine the fractal dimensions of the pattern the Fractal Analysis System software were used on the basis of the made photographs with same lighting conditions. The Fig. 1. shows a typical patterns row.

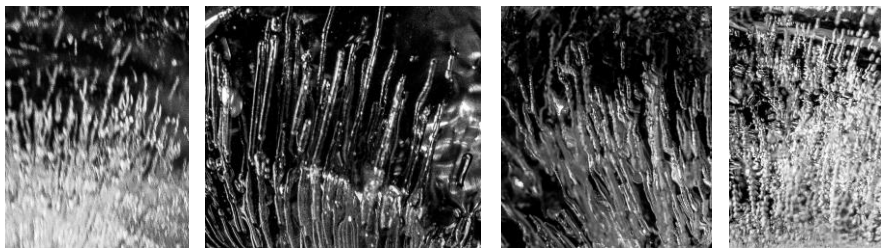

Fig. 1. Typical water freezing generated patterns: rain, tap, spring and distilled water .

During the examination 20 rainwater, 12 tap water, 7 spring water and 7 distilled water samples were used. The base of 5-5 picture of every samples the following parameters were determination:

1. Fractal dimension of the borderline between ice (black) and air bubbles (non-black).
2. Coverage (ratio of non-black area in%).
3. Fractal dimension of the surface of the bubbles based of grayscale pictures.

For determination fractal dimension of the borderline between ice and air bubbles the box-counting method were used. The air bubbles surface fractal dimensions were calculated from box-counting results of several spectrums of grayscale.

In case of several water types Fig. 2 shows the dimension of borderline and covering, Fig. 3 shows the results with standard deviation of air bubbles surface fractal dimension.

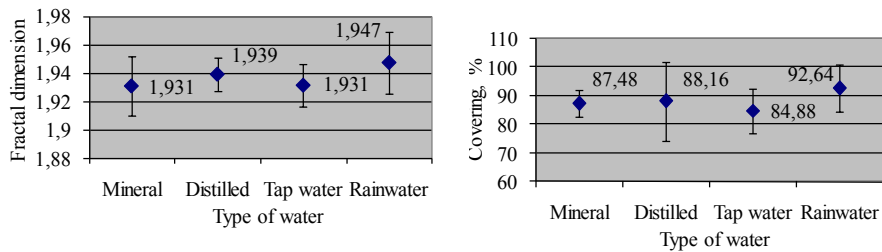

Fig. 2. Borderline fractal dimension

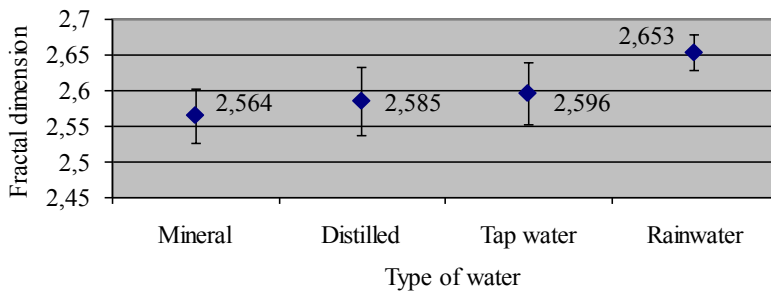

Fig. 3. Fractal dimensions of air bubbles surfaces.

The base of results the followings are summarized:

In air bubbles borderline fractal dimensions at the different types of water samples could not be found characteristic difference. The same can be said also for covering. The coverage can be related to the air content of water. The result is that no significant difference is confirms that the air content of the water type independent. The waters air content dependence of the pre life and freezing

conditions are well known, but these were the same in these samples, so these results understandable.

The surface fractal dimensions of the air bubbles in based of grayscale images in case of rain water is largest. The other three types of water this value is definitely smaller and can not be determined a significant difference between them, so the difference in the samples on the fractal dimension does not appear. So, from the fractal dimension of air bubbles surface we can estimate properly only that the examined water sample made from rainwater or not. The larger value at rain water is may be explained that the rain water is unfiltered, while the other tested water samples passing through filters (soil, membranes, chemical filtration) before gathering samples.

ACKNOWLEDGEMENTS

This work was supported by Doctoral School of Engineering, Szent István University, Gödöllő, Hungary.

REFERENCES

1. CARO P. 1993, Water, McGraw-Hill, Inc. New York.
2. Fractal Analysis System for Windows 3.4.7, National Agriculture and Food Research Organization (NARO), Japan.
3. MADRAZO C., TSUCHIYA T., SAWANO H., KOYANAGI K. 2009, Air bubbles in ice by simulating freezing phenomenon, The Journal of the Society for Art and Science, Vol. 8. No.1, pp. 35-42.

EFFECT OF HEAVY METALS ON SOIL METHANOTROPHIC ACTIVITY

Anna Walkiewicz, Małgorzata Brzezińska

Department of Natural Environment Biogeochemistry,
Institute of Agrophysics Polish Academy of Sciences
Doświadczalna 4, 20-290 Lublin, Poland, a.walkiewicz@ipan.lublin.pl

Soil has a natural ability to oxidize methane (CH₄). It is one of the most significant gases responsible for the greenhouse effect through the ability of absorbing infrared radiation. The atmospheric concentration of CH₄ has increased and more than doubled during the past 200 years (Mancinelli, 1995). Simultaneously soil acts as a reservoir or a sink for many kinds of pollutants (Sheng *et al.*, 2012). Heavy metal ions are the most toxic inorganic pollutants

which occur in soils and can be of natural or anthropogenic origin. Widespread contamination of the environment justifies analyses of the activity of methane oxidizing bacteria (MOB) in soil in the presence of heavy metals

The aim of the study was to analyze methanotrophic activity of soil contaminated with heavy metals in a controlled laboratory conditions. Methanotrophic activity was calculated by measuring decrease of CH₄ concentration (1% v/v was added) with the time in the headspace expressed in mg C-CH₄ kg⁻¹. Additional test was measurement of dehydrogenase activity (DHA) which present sensitivity of soil microbiology to toxic effect of heavy metals.

The soil under investigation was classified as *Mollic Gleysol*. The soil was contaminated with heavy metals (Pb, Ni and Zn) corresponding to the limit values established by the Polish legislation to a depth of 0 to 30 cm of soil (based on Journal of Laws of the Republic of Poland Dz.U.06.137.984). It is also the most active methanotrophic zone.

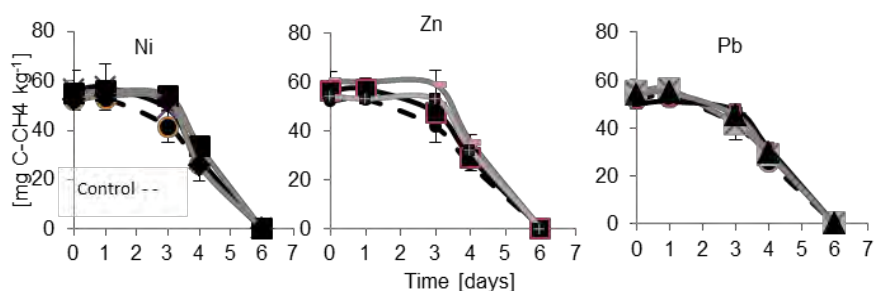

Fig.1. Decrease of CH₄ concentration with the time in the headspace of soil contaminated by Zn, Ni, Pb in doses established on Polish legislation ($Zn_{0.5} = 60 \text{ mg kg}^{-1}$, $Zn_1 = 120 \text{ mg kg}^{-1}$, $Zn_2 = 240 \text{ mg kg}^{-1}$; $Ni_{0.5} = 17.5 \text{ mg kg}^{-1}$, $Ni_1 = 35 \text{ mg kg}^{-1}$, $Ni_2 = 70 \text{ mg kg}^{-1}$; $Pb_{0.5} = 30 \text{ mg kg}^{-1}$, $Pb_1 = 60 \text{ mg kg}^{-1}$, $Pb_2 = 120 \text{ mg kg}^{-1}$) and non contaminated control soil.

Tested soil is very active and all analyzed samples completely oxidized added methane. The results indicate that addition of heavy metals in used doses slightly changed capacity of tested soil to oxidize CH₄. This indicates that such soil contamination does not interfere with activity of MOB. Under our experimental conditions, DHA inhibition increased in the order $Pb > Zn > Ni$. Generally, with the increase of used doses, DHA decreasing was observed.

REFERENCES

1. MANCINELLI R. L., 1995. The regulation of methane oxidation in soil. *Annual Review of Microbiology*, 49, p. 581–605.
2. SHENG J., WANG X., GONG P., TIAN L., YAO T., 2012. Heavy metals of the Tibetan top soils, *Environ Sc. Pollut. Res.*, 19, p. 3362–3370.

**PHYSIOLOGICAL RESPONSES OF CUCUMBER PLANTS
WITH PARTIAL ROOTZONE DRYING**

Joanna Wróbel, Artur Nosalewicz

Department of Soil and Plant System,
Institute of Agrophysics Polish Academy of Sciences in Lublin
Doświadczalna 4, 20-290, Poland
w.joanna@ipan.lublin.pl

Soil heterogeneity is a natural state of root growth environment, and a large range of its variability can be observed even at the distance scale of the range of a plant root system. That type of variability of soil properties occurs in the field as a result of natural processes and cultivation. Partial rootzone drying (PRD) techniques are used as a water saving method of plant drying. In PRD only part of the root system is exposed to watering at one round of irrigation while the rest part is left in drying soli. This technique has been proposed for decreasing volume water used for irrigation and was applied to many plant species reducing yield losses caused by insufficient precipitation.

The aim of the studies was to evaluate the physiological response of cucumber plants exposed to water deficit affecting part of one plant root system.

Two-week old seedlings were grown in hydroponic culture in controlled environment with root system divided into two containers with Hoagland solutions. Water stress was induced by exchanging Hoagland nutrient solution with solution containing 20% of polyethylene glycol 8000 (PEG-8000) in one of nutrient chambers.

The leaf CO₂ assimilation rate (A), transpiration (E) and stomatal conductance (g_s) that are indicator of overall plant condition measured during first 1-3days of stress. At the same time the length, surface area and water uptake by roots were used to observe effect of various water potential on parts of root system. The data on root length and surface area were used to calculate efficiency of stressed and non stressed parts of root system in water uptake.

We observed that induced partial root zone water deficit has effect on photosynthesis, growth, yield and transpiration depending on the fraction of roots in the stressed solution. This study indicated that partially water stress had various effects on plant functions as affected by the fraction of roots that grows in stressed solution.

The obtained results are important indicators that may be used for evaluation of efficiency of partial rootzone drying.

REFERENCES

1. FUSHENG LI, CAIHUI W., FUCANG Z., JIANHUA Z., MENGLING N., SHAOZHONG K., *Agricultural Water Management* 97 (2010) 1156-1164, Water-use efficiency and physiological responses of maize under partial root-zone irrigation.
2. LI-SONG TANG, YAN LI, JIANHUA Z., *Agricultural Water Management* 97 (2010) 1527-1533, partial rootzone irrigation increases water use efficiency, maintains yield and enhances economic profit of cotton in arid area.
3. LI-SONG TANG, YAN LI, JIANHUA Z., *Plant Soil* (2010) 337:413-423, Biomass allocation and yield formation of cotton under partial rootzone irrigation in arid zone.